

March 2023

## TECHNOLOGY ASSESSMENT

# Utility-Scale Energy Storage

Technologies and Challenges for an Evolving Grid

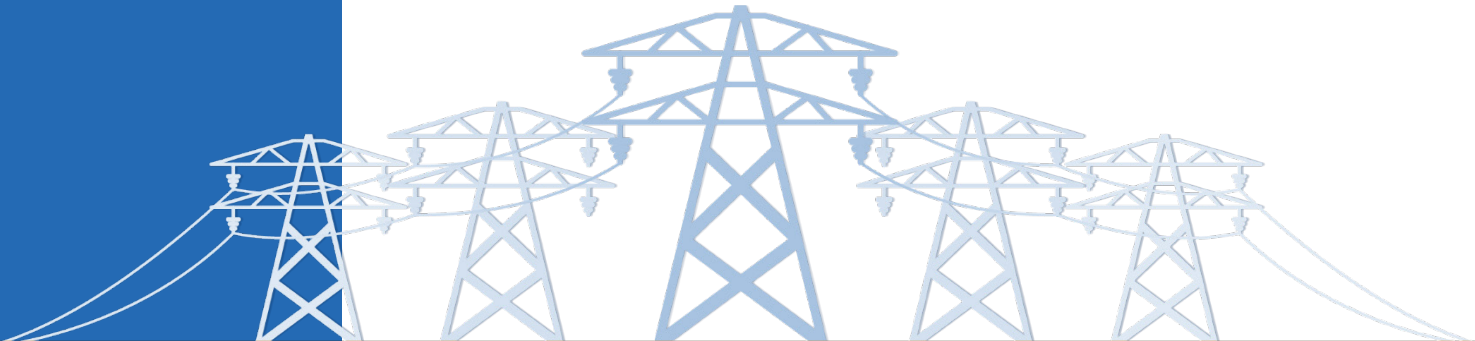

The cover image displays images of a gas-powered turbine for electricity generation, and pumped hydroelectric, flywheel, and battery energy storage technologies.

Cover sources: GAO (illustration); contributor\_aerial/Regan/malp/filins/stock.adobe.com (photos left to right). | GAO-23-105583

# Utility-Scale Energy Storage Technologies and Challenges for an Evolving Grid

## Why GAO did this study

The U.S. electricity grid connects more than 11,000 power plants with around 158 million residential, commercial, and other consumers. Energy storage technologies have the potential to enable several improvements to the grid, such as reducing costs and improving reliability. They could also enable the growth of solar and wind energy generation.

GAO conducted a technology assessment on (1) technologies that could be used to capture energy for later use within the electricity grid, (2) challenges that could impact energy storage technologies and their use on the grid, and (3) policy options that could help address energy storage challenges.

To address these objectives, GAO reviewed agency documents and other literature; interviewed government, industry, academic, and power company representatives; conducted site visits; and convened a virtual meeting of experts in collaboration with the National Academies of Sciences, Engineering, and Medicine. GAO is identifying policy options in this report (see p. 2).

View [GAO-23-105583](#). For more information, contact Brian Bothwell at (202) 512-6888, [bothwellb@gao.gov](mailto:bothwellb@gao.gov).

## What GAO found

Technologies to store energy at the utility-scale could help improve grid reliability, reduce costs, and promote the increased adoption of variable renewable energy sources such as solar and wind. Energy storage technology use has increased along with solar and wind energy. Several storage technologies are in use on the U.S. grid, including pumped hydroelectric storage, batteries, compressed air, and flywheels (see figure). Pumped hydroelectric and compressed air energy storage can be used to store excess energy for applications requiring 10 or more hours of storage. Lithium-ion batteries and flywheels are used for shorter-duration applications such as keeping the grid stable by quickly absorbing or discharging electricity to match demand. Flow batteries represent a small fraction of total energy storage capacity and could be used for applications requiring 10 or more hours of storage. Metal-air batteries are being evaluated for applications requiring 10 or more hours of storage.

Pumped Hydroelectric (left) and Lithium-Ion Battery (right) Energy Storage Technologies

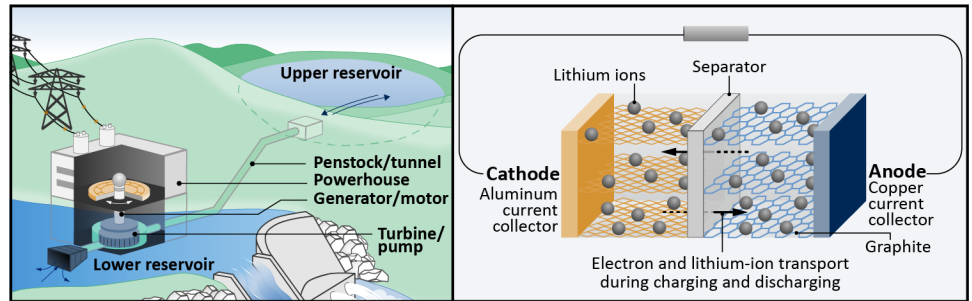

Sources: Department of Energy (left); GAO (right). | GAO-23-105583

Energy storage technologies face multiple challenges, including:

- Planning.** Planning is needed to integrate storage technologies with the existing grid. However, accurate projections of each technology's costs and benefits could be difficult to quantify. Further, refinement of costs, benefits, and other data are needed to inform the planning process.
- Regulation.** Rules and regulations vary across regions and states, which forces energy storage project developers to navigate a patchwork of potential markets. Developers that want to deploy storage across multiple markets may need to conduct separate analyses to determine each region's regulatory outlook and profit potential.
- Standardization.** Codes and standards may need revising and must keep pace with maturing technologies to minimize public safety and welfare risks. However, the technology's evolution and deployment is outpacing codes and standards development. As a result, entities seeking to deploy new technologies may face challenges applying existing codes and standards to new technologies.
- Valuation.** Realizing the potential of energy storage technologies may depend on the ability to value investments. For example, profit potential can vary because regions and states value storage differently, reflecting local market rules and regulations.

GAO developed six high-level policy options in response to these challenges. These policy options are provided to inform policymakers of potential actions to address the policy challenges identified in this technology assessment. They identify possible actions by policymakers, which include Congress, federal agencies, state and local governments, academic and research institutions, and industry. The status quo option illustrates a scenario in which policymakers do not intervene with ongoing efforts.

**Policy Options to Address Challenges to Utility-Scale Energy Storage**

Policy options and implementation approaches	Opportunities	Considerations
<p><b>Status quo</b> (report p. 48) Policymakers could maintain the status quo through:</p> <ul style="list-style-type: none"> <li>• Tax credits and funding</li> <li>• Research and development</li> </ul>	<ul style="list-style-type: none"> <li>• Previous plans and programs by states would continue, including actions for energy storage.</li> <li>• The federal government has various national capabilities to support energy storage technology incentives and demonstration.</li> <li>• DOE support for storage research and development would continue.</li> </ul>	<ul style="list-style-type: none"> <li>• Some policymakers may lack sufficient information to make decisions on evolving storage capabilities.</li> <li>• Storage development, deployment, and use could be left dependent on forces outside policymakers’ control.</li> </ul>
<p><b>Integration</b> (report p. 50) Policymakers could include clear goals and next steps in plans to help integrate storage, by:</p> <ul style="list-style-type: none"> <li>• Establishing roadmaps, based on storage costs and benefits</li> <li>• Assessing storage in plans</li> </ul>	<ul style="list-style-type: none"> <li>• Storage planning could help policymakers identify and remove barriers to energy storage deployment.</li> <li>• Plans could increase investors’ confidence and help them determine storage investments.</li> </ul>	<ul style="list-style-type: none"> <li>• Plans that seek to alter conventional grid planning could be difficult to execute.</li> <li>• Stakeholders have set different goals for low-carbon electric generation.</li> <li>• Planning depends on factors such as location suitability; not every technology is suited for every location.</li> </ul>
<p><b>Regulation</b> (report p. 52) Policymakers could revise and enact rules and requirements for how storage is defined, used, or owned by:</p> <ul style="list-style-type: none"> <li>• Identifying market barriers</li> <li>• Establishing targets or mandates</li> <li>• Modernizing ownership models</li> </ul>	<ul style="list-style-type: none"> <li>• Could promote energy storage technologies by improving grid efficiency while reducing costs for all customers.</li> <li>• Could help lower costs and reduce the timeline for interconnection.</li> <li>• Could accelerate permit approval timelines.</li> </ul>	<ul style="list-style-type: none"> <li>• Regulations differ across states, which could make finding the right regulatory model to achieve energy goals a challenge.</li> <li>• Integrating new technologies with conventional grid planning can be challenging.</li> <li>• Changes to rules and regulations could exclude certain technologies.</li> </ul>
<p><b>Standardization</b> (report p. 54) Policymakers could update or create new codes and standards and provide education on storage safety risks.</p>	<ul style="list-style-type: none"> <li>• Could help stakeholders operate storage systems more safely.</li> <li>• Standards placed into regulations could help address storage performance requirements.</li> </ul>	<ul style="list-style-type: none"> <li>• Codes and standards take time to develop and could be outdated if not adopted in a timely manner.</li> <li>• Standards may be ambiguous, which could make it difficult to design storage systems.</li> </ul>
<p><b>Support manufacturing and adoption</b> (report p. 56) Policymakers could support actions to help energy storage manufacturing and adoption challenges by:</p> <ul style="list-style-type: none"> <li>• Enacting battery reuse and recycling policies</li> <li>• Conducting outreach</li> <li>• Targeting activities to support storage development and deployment</li> </ul>	<ul style="list-style-type: none"> <li>• Reuse and recycling policies could increase the recovery of products and materials.</li> <li>• Stakeholder outreach and informational programs could help overcome awareness and familiarity challenges.</li> <li>• Federal and state financial support for longer-duration energy storage development and demonstration could be important in a future electricity system powered by wind and solar generation.</li> </ul>	<ul style="list-style-type: none"> <li>• Incentives and motivation to invest in new recycling applications is limited.</li> <li>• Funding may fluctuate year to year or favor short-term projects.</li> <li>• Development of new systems could be difficult because of engineering and economic uncertainty, particularly for longer-duration storage.</li> <li>• Low-cost, flexible natural gas generation could make it more difficult for new pumped hydroelectric facilities to compete.</li> </ul>
<p><b>Provide incentives</b> (report p. 58) Policymakers could create mechanisms to incentivize storage deployment, by:</p> <ul style="list-style-type: none"> <li>• Providing incentives, such as loan guarantees or tax credits</li> <li>• Considering policies to encourage the capture of multiple revenue streams</li> </ul>	<ul style="list-style-type: none"> <li>• Financial incentives could help developers and companies develop storage technologies.</li> <li>• Technologies with longer durations may benefit from policies that help industry to capture their full value.</li> </ul>	<ul style="list-style-type: none"> <li>• Incentives could lead to unintended outcomes for governments or developers, and some stakeholders may not believe they are necessary.</li> <li>• Technology value varies by region, which may affect storage incentives, valuation, and revenue streams.</li> <li>• Environmental and social costs and benefits could be difficult to quantify.</li> </ul>

This is a work of the U.S. government and is not subject to copyright protection in the United States. The published product may be reproduced and distributed in its entirety without further permission from GAO. However, because this work may contain copyrighted images or other material, permission from the copyright holder may be necessary if you wish to reproduce this material separately.

# Table of Contents

Introduction .....	1
1 Background .....	3
1.1 How does the grid work?.....	3
1.2 What is energy storage? .....	9
1.3 Why energy storage?.....	10
1.4 History of energy storage technologies.....	12
1.5 Factors affecting economic viability .....	13
1.6 Legal and regulatory considerations .....	15
2 Utility-Scale Energy Storage Technologies.....	18
2.1 Multiple storage technologies are available .....	18
2.2 Different energy storage durations have different uses on the grid.....	35
3 Several Challenges May Hinder Energy Storage Technology Development and Use ...	39
3.1 Planning for storage technologies .....	39
3.2 Challenging regulatory environment.....	42
3.3 Existing codes and standards do not fully address energy storage technologies .....	43
3.4 Crosscutting challenges .....	44
3.5 Valuing energy storage .....	46
4 Policy Options to Address Energy Storage Technology Challenges.....	48
4.1 Status quo .....	48
4.2 Integrating storage technologies.....	50
4.3 Revising and enacting rules and requirements .....	52
4.4 Updating or creating codes and standards.....	54
4.5 Addressing crosscutting challenges .....	56
4.6 Incentivizing energy storage.....	58

5 Agency and Expert Comments ..... 61  
Appendix I: Objectives, Scope, and Methodology ..... 63  
Appendix II: Expert Participation ..... 68  
Appendix III: GAO Contacts and Staff Acknowledgments ..... 69

## Figures

Figure 1: The electricity grid .....	4
Figure 2: Example depicting electricity system load .....	5
Figure 3: U.S. electric power markets and interconnections .....	7
Figure 4: Independent system operators and regional transmission organizations.....	8
Figure 5: Selected energy storage technology performance characteristics .....	9
Figure 6: Examples of energy storage applications on the electricity grid.....	11
Figure 7: Hypothetical example of curtailed wind energy on a grid using simulated data.....	11
Figure 8: Total installed costs (energy capacity) of large-scale battery storage systems from 2015-2019 .....	13
Figure 9: Percent of utility-scale energy storage in operation by technology type .....	19
Figure 10: Simplified interconnection study process .....	41
Figure 11: Examples of state energy storage efforts .....	51



## Abbreviations

DOE	Department of Energy
EIA	Energy Information Administration
FERC	Federal Energy Regulatory Commission
ISO	Independent System Operator
MW	Megawatt
National Academies	National Academies of Sciences, Engineering, and Medicine
NERC	North American Electric Reliability Corporation
RTO	Regional Transmission Organization



March 30, 2023

Congressional Addressees

Energy storage technologies—such as batteries, flywheels, compressed air, and pumped hydroelectric power—have several potential benefits.<sup>1</sup> For example, the ability to store energy—especially for several hours or longer—could reduce costs, increase the electricity grid’s reliability, and improve its ability to recover from disruptions. Storage technologies could also promote increased adoption of renewable energy sources such as solar and wind by capturing their excess power and returning it to the grid when these sources are less available. However, energy storage, along with renewable energy generation, may require changes in the way the power system is organized and operated.<sup>2</sup>

The federal government has taken several steps to explore or promote energy storage technologies. For example, in 2021 the Infrastructure Investment and Jobs Act appropriated \$505 million to the Department of Energy (DOE) for energy storage demonstration projects for fiscal years 2022 to 2025.<sup>3</sup> The act also required DOE to study codes and standards for energy storage systems and establish a grant program to enhance U.S. battery manufacturing. Further, the Inflation Reduction Act of 2022 created and expanded tax credits for investment in energy storage technology.<sup>4</sup> Within the executive branch, the Federal Energy Regulatory Commission (FERC) issued orders in 2018 and 2019 to remove barriers to market participation for energy storage technologies.

We prepared this report under the authority of the Comptroller General to assist Congress with its oversight responsibilities, in light of broad congressional interest in utility-scale energy storage technologies.<sup>5</sup> We examined (1) technologies that could be used to capture energy for later use within the electricity grid, (2) challenges that could impact energy storage technologies

---

<sup>1</sup>For the purposes of this report, we discuss pumped hydroelectric storage; lithium ion, and other battery technologies; compressed air energy storage; and flywheels as examples of energy storage technologies. We do not discuss concentrated solar thermal energy for this report, because it cannot take energy from the grid, or hydrogen, because it was not sufficiently well established during our review.

<sup>2</sup>Energy storage technologies are systems that are capable of receiving electric energy from the grid and storing it for later injection of electric energy back to the grid.

<sup>3</sup>Pub. L. No. 117-58, 135 Stat. 429 (2021).

<sup>4</sup>Pub. L. No. 117-169, § 13102, 136 Stat. 1818, 1913-21.

<sup>5</sup>For the purposes of this report, we are defining utility-scale as systems that have at least 1 megawatt (MW) of output, are located in a centralized location, and are on the utility’s side of the meter.

and their use on the grid, and (3) policy options that could help address energy storage challenges.

We focused this technology assessment on utility-scale energy storage systems, selecting pumped hydroelectric storage, batteries, compressed air energy storage, and flywheels as example technologies. We do not discuss concentrated solar thermal energy in this report because it cannot take energy from the grid, and hydrogen because it was not sufficiently established during our review. We reviewed agency documents and other literature; interviewed agency officials, experts and stakeholders from industry, and power companies, among others; conducted site visits; and held a virtual meeting of experts. The meeting included a non-generalizable sample of 15 experts selected based on their technical, economic, regulatory, operational, or policy expertise. See appendix I for a detailed description of our objectives, scope, and methodology.

We conducted our work from December 2021 to March 2023 in accordance with all sections of GAO's Quality Assurance Framework that are relevant to technology assessments. The framework requires that we plan and perform the engagement to obtain sufficient and appropriate evidence to meet our stated objectives and to discuss any limitations to our work. We believe that the information and data obtained, and the analysis conducted, provide a reasonable basis for any findings and conclusions in this product.

# 1 Background

## 1.1 How does the grid work?

The electricity grid is a massive feat of engineering, which one author called “the most complex machine ever made.”<sup>6</sup> In the U.S., it connects more than 11,000 power plants with over 158 million residential, commercial, and other customers via millions of power lines. It has four distinct functions: generation, electricity transmission, distribution, and grid operations.<sup>7</sup> See figure 1

for a representation of the grid. Power plants generate electricity by converting other forms of energy, such as chemical energy from fuel, mechanical energy from wind or water, and nuclear energy. Once generated, electricity is a uniform resource that is interchangeable with electricity from any other source. The grid carries this electricity first through high-voltage, high-capacity *transmission* lines. The electricity is then transformed to a lower voltage and sent through the local *distribution* lines to homes and businesses.

---

<sup>6</sup>Schewe, Phillip F., *The grid: a journey through the heart of our electrified world* (Washington, DC: Joseph Henry Press, 2007).

<sup>7</sup>Generation facilities produce electricity. Transmission lines move electricity between power plants and points where it is delivered to customers or other electric systems. Distribution delivers energy to retail customers.

**Figure 1: The electricity grid**

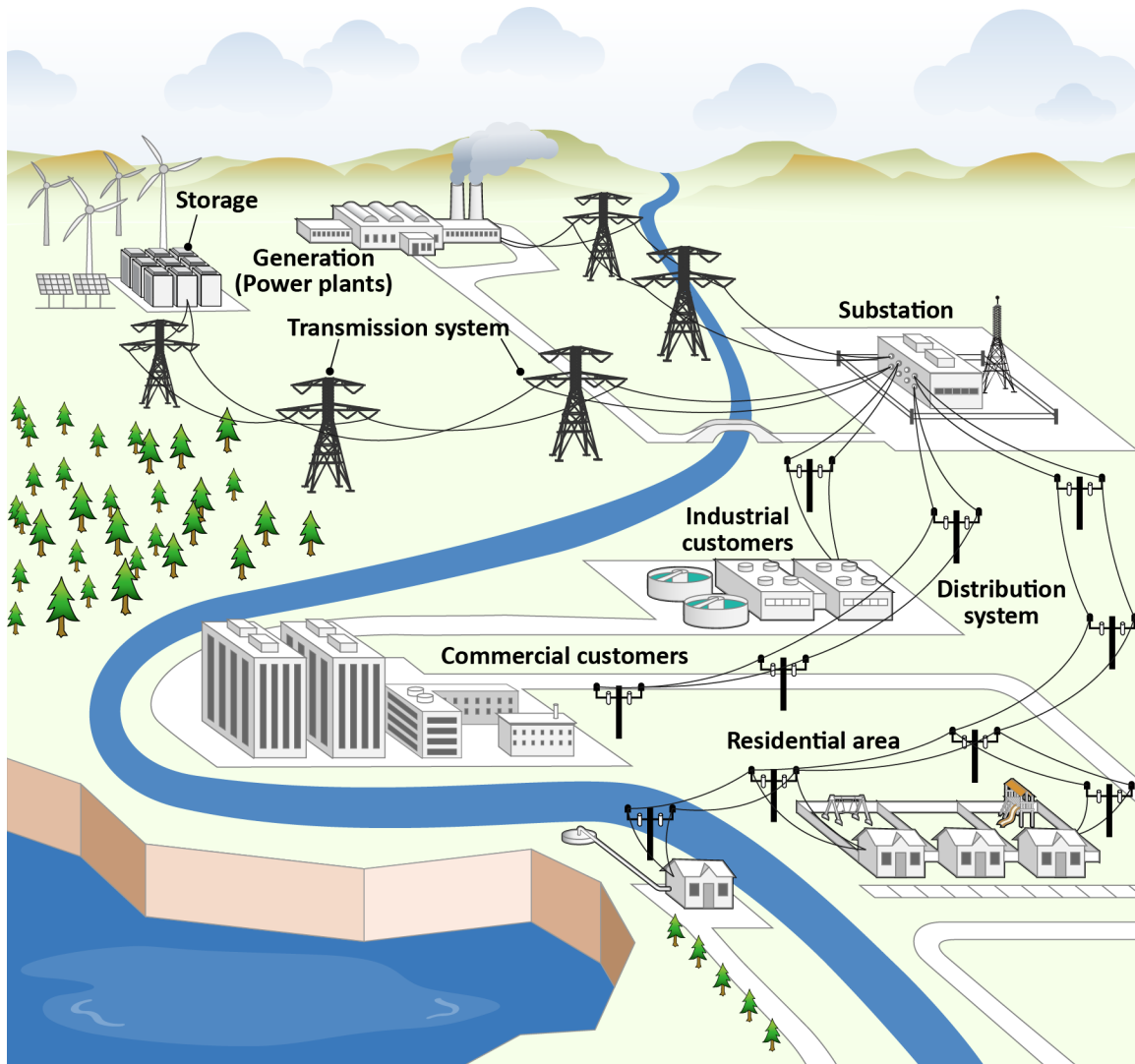

Source: Adapted from GAO-18-402 and GAO-21-421. | GAO-23-105583

Grid operators must ensure that electricity supply constantly matches power demand. This balancing act requires them to forecast electricity demand and schedule and operate power plants to meet demand, which varies by time of day and year, since it is difficult to economically store large quantities of electricity. As such, electricity must be produced the instant it is needed and used. To do this, grid operators send minute-by-minute signals to power plants to adjust

output. One key pattern they must follow is the rise in consumer electricity demand throughout the day, in many areas, reaching peak demand in the late afternoon or early evening. Typically, grid operators use a steady flow of electricity from *baseload* power plants, which run continuously and are the least expensive to operate. As demand increases to its peak, operators progressively increase the electricity supplied by *peaker plants*—electricity generators reserved for

operation during the hours of highest daily, weekly, or seasonal electricity loads—and other generators that are more expensive to operate but can be quickly brought online (see fig. 2).

**Figure 2: Example depicting electricity system load**

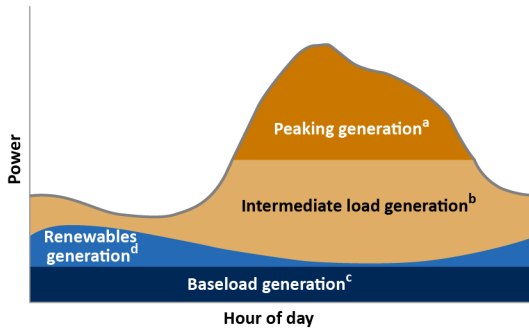

Source: Sandia National Laboratories. | GAO-23-105583

<sup>a</sup>Peaking generation is electricity reserved for operating during the hours of highest daily, weekly, or seasonal electricity loads.

<sup>b</sup>Intermediate load generation is normally operated on a daily cycle to serve on-peak loads during the day, but not off-peak loads during nights and weekends.

<sup>c</sup>Baseload generation serves the minimum level of electric power demand of a region, or customer required over a given period of time at a steady rate.

<sup>d</sup>Renewables generation represents variable generation primarily from wind or solar sources, whose peak generation does not necessarily coincide with electricity system periods of peak demand.

Several factors have made the task of matching electricity supply and demand even more complex. Variable electricity sources such as wind and solar power are supplying an increasing share of electricity, but their output varies with the weather and does not always match demand. Further, the increasing use of variable energy resources, interaction of such energy sources with traditional generation sources, and changing role of electricity customers have increased the

complexity of matching electricity supply with demand at all times.

Grid operators conduct planning activities to determine grid infrastructure adequacy, identify capacity needs, and evaluate the cost and effectiveness of potential solutions to address these needs. Utilities deal with uncertainty partly by producing a range of forecasts based on demographic and economic factors, and by maintaining excess generation capacity, known as reserves. Additionally, utilities use models to help choose the least-cost combination of electricity generating resources to meet demand in order to reduce costs. State regulators approve of utility investments before facilities are built or when utilities seek to recover costs in the rates consumers are charged. Further, some states use integrated resource planning processes to determine which facilities should be built. This process is intended to meet future power demand by identifying the need for generating capacity and determining the best resource mix to meet system needs at the lowest costs.

The electricity grid in the lower 48 states is made up of three main parts, known as interconnections, which operate largely independent of each other, with limited

power transfers between them.<sup>8</sup> See figure 3 for maps of interconnections and U.S. electric power markets. Further, how power is bought and sold varies by region and there is a mix of regulatory market environments. Some utilities may operate under a mix of market environments. Further, some utilities may be investor-owned and regulated by public policy, while others may be publicly owned and regulated through their ownership, in addition to many state and federal laws. U.S. utilities operate in traditionally regulated and deregulated markets.

- **Traditionally regulated markets.** In traditionally regulated markets, utilities are typically solely responsible for

generating, transmitting, and distributing electricity to their customers.

- **Deregulated markets.** In deregulated markets, utilities that serve retail customers cannot own power plants; they are only responsible for delivering electricity to customers, and for customer billing.<sup>9</sup> In such markets, electricity generating entities typically sell the electricity they generate through competitive power markets. Independent system operators (ISO) and regional transmission organizations (RTO), formed in response to FERC orders, are groups that coordinate, control, and monitor the electric grid in these areas. See figure 4 for a map of ISOs and RTOs.

---

<sup>8</sup>The Western, Eastern, and Electric Reliability Council of Texas (ERCOT) interconnections consist of balancing authorities which can be independent system operators, regional transmission organizations, or individual power companies. Balancing authorities have balancing responsibilities for a specific portion of the power system and ensure that power system supply and demand are balanced, which is required to maintain safe and reliable operation of the power system.

<sup>9</sup>Transmission systems are lines and equipment that move electricity from where it is supplied to where it is delivered to customers or other systems.

**Figure 3: Interconnections and U.S. electric power markets**

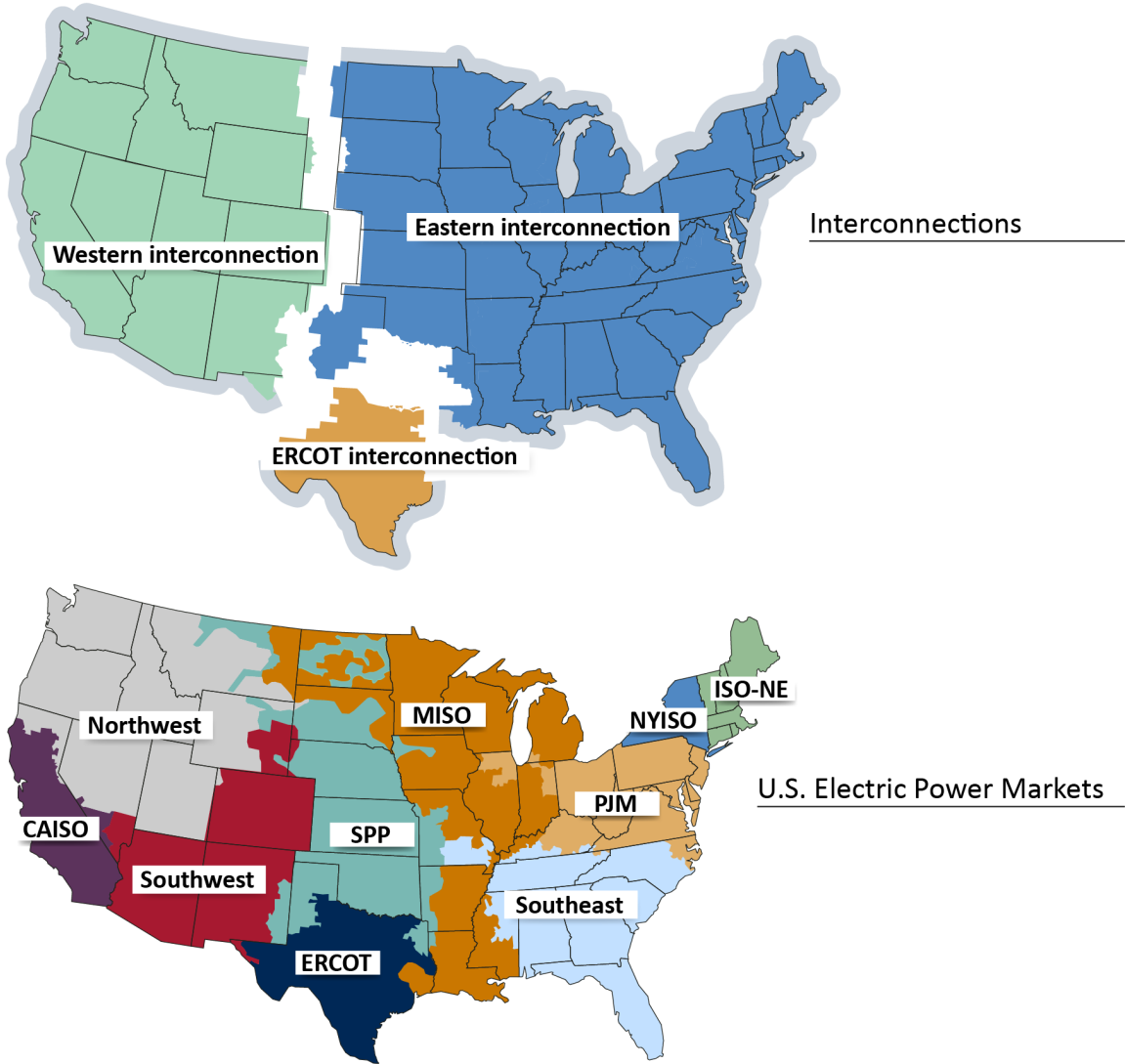

CAISO = California ISO  
 ERCOT = Electric Reliability Council of Texas  
 ISO = Independent System Operator  
 ISO-NE = New England ISO  
 MISO = Midcontinent ISO  
 NYISO = New York ISO  
 SPP = Southwest Power Pool

Sources: Federal Energy Regulatory Commission; Derived from image courtesy of North American Electric Reliability Corporation and used with permission; Map Resources (map). | GAO-23-105583



**Figure 4: Independent system operators and regional transmission organizations**

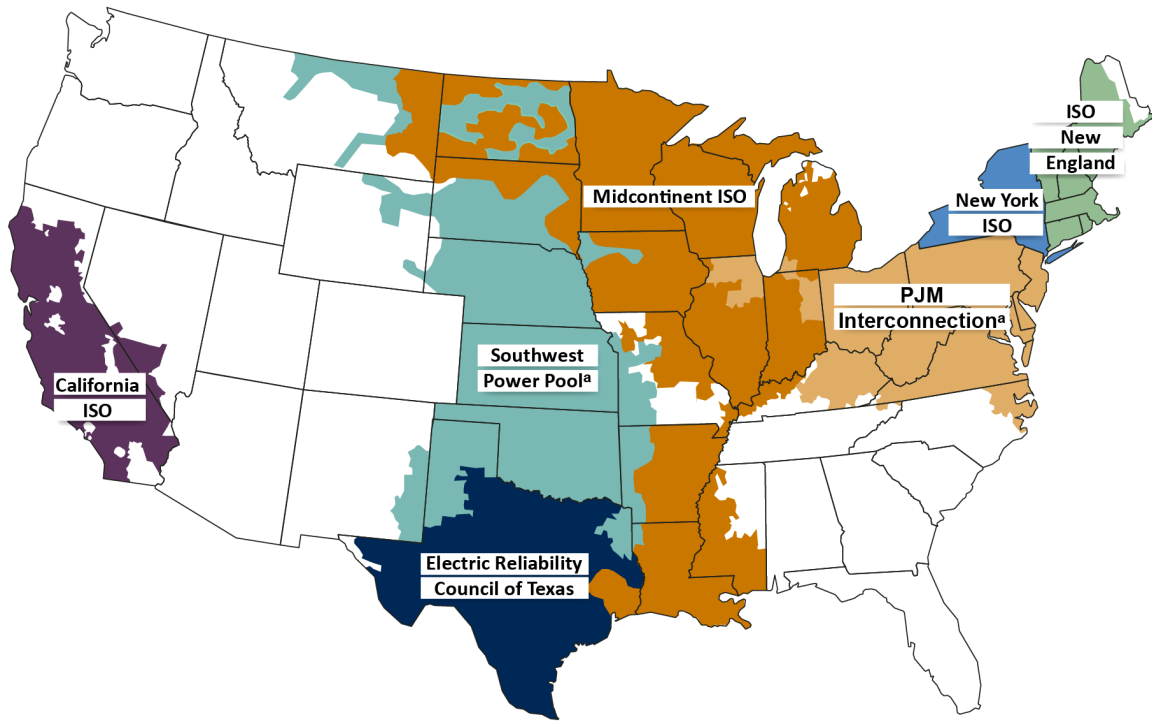

ISO = Independent System Operator

Sources: Federal Energy Regulatory Commission; Map Resources (map). | GAO-23-105583

<sup>a</sup>PJM interconnection and Southwest Power Pool are Regional Transmission Organizations.

Responsibility for power industry regulation is divided among states and the federal government. For example, the Federal Power Act gives FERC the responsibility to regulate the transmission and wholesale sale of electricity in interstate commerce, and to ensure that the rates for such transmission and wholesale sales are just and reasonable.<sup>10</sup> State entities, such as public utility commissions, regulate utility management, operations, and electricity rate structures. In some regions, ISO's and RTOs manage electricity transmission and wholesale electricity markets. According to the National

Academies of Sciences, Engineering, and Medicine (National Academies), this divided responsibility contributes to making it difficult to make generalizations about many aspects of the U.S. electricity system.

According to a National Academies consensus study, it can be challenging to determine who is in charge of planning, developing, and ensuring future power system integrity.<sup>11</sup> In the U.S., no single planner or designer is responsible for the electricity system. The grid has been developed in an incremental and piecemeal process driven by the sometimes

<sup>10</sup>16 U.S.C. §§ 824, 824d.

<sup>11</sup>National Academies of Sciences, Engineering, and Medicine, *The Future of Electric Power in the United States* (Washington, D.C.: National Academies Press. 2021).

divergent interests of federal, state, regional, and local authorities operating differently in their respective areas. This incremental process has shaped how the grid has evolved, and according to this National Academies study, how it will continue to evolve.

## 1.2 What is energy storage?

Types of energy storage technologies include pumped hydroelectric storage, lithium-ion and other battery technologies, compressed air energy storage, and flywheels.<sup>12</sup> These technologies have different performance characteristics that may make them more suitable for some grid services than others. For example, they have different *round trip efficiencies*, a measure of the amount of energy lost when the energy storage system charges and discharges. They also have many different *duration* times—the amount of time that a storage technology can produce electricity. These durations range from seconds to hours. They also have different *capacities*, or maximum amounts of power that they can discharge onto the grid. Capacity can reach 1,000 megawatts (MW) for pumped hydroelectric and compressed air energy storage systems.<sup>13</sup> Technologies like batteries and flywheels have smaller capacities and shorter discharge times. See figure 5 for information on selected technology *power*, the maximum amount of electricity that the storage can provide, and duration.

**Figure 5: Simplified description of selected energy storage technology performance characteristics**

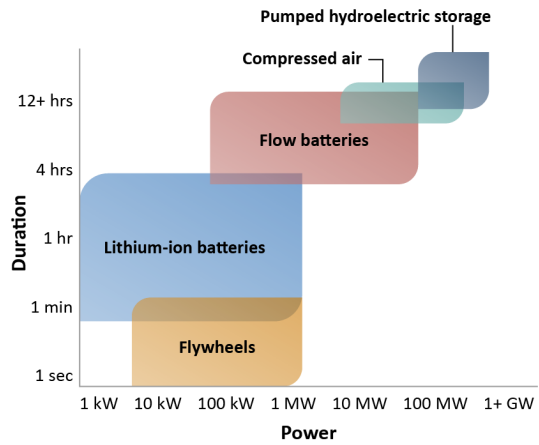

Source: Derived from image courtesy of the Interstate Renewable Energy Council and used with permission. | GAO-23-105583

Note: Because technology characteristics are quickly evolving this figure may not be representative of the full range of technology capabilities.

The grid was not designed with advanced energy storage in mind. Energy storage may be challenging to integrate with the existing infrastructure because it may not fit into the existing policy and regulatory framework. For example, it may act as transmission, electricity demand, and infrastructure, along with its ability to shift between these roles, but policies and regulations may prevent it from offering multiple functions on the grid.<sup>14</sup> As we previously reported, market rules and regulations may not always clearly address whether entities may own or operate storage and how, if at all, investment costs can be

<sup>12</sup>We do not discuss concentrated solar thermal energy for this report because it cannot take energy from the grid, and hydrogen because it was not sufficiently established during our review.

<sup>13</sup>A megawatt (MW) is a unit of electric power. One gigawatt is 1,000 megawatts. A battery with 1MW capacity and a

maximum discharge time of four hours at that capacity, could supply up to 4 megawatt-hours of electricity.

<sup>14</sup>Transmission systems are lines and equipment that move electricity from where it is supplied to where it is delivered to customers or other systems.

recovered.<sup>15</sup> Further, some states do not allow utilities to own generation assets, and storage may be classified as a generation asset in some areas.

Energy storage technologies may face other constraints. For example, pumped hydroelectric storage requires an elevation change between its top and bottom reservoirs. Some technologies may also require system components such as inverters, temperature regulation or other equipment. For example, lithium-ion battery systems may require cooling to reduce the risk of thermal runaway and slow system degradation.

### 1.3 Why energy storage?

The U.S. power system is designed for just-in-time delivery of electricity, and very little of our electricity is stored. However, energy storage technologies create several potential benefits. See figure 6 for examples of energy storage applications and their use on the electricity grid.

- **Cost.** Energy storage technologies can enable *arbitrage*, which is defined as purchasing energy during periods of low prices and selling it when the available alternatives are more expensive. Services like arbitrage may also represent potential *value streams* that may accrue to utilities, and others. Storage can also reduce cost by providing a source of electricity in a high-demand area, thus deferring the need to build new power lines.
- **Reliability.** Storage technologies can improve reliability by addressing supply disruptions. Furthermore, they can help keep the grid frequency and voltage stable by quickly absorbing or discharging electricity to match demand—services known as *frequency regulation* and *voltage support*.
- **Resiliency.** Energy storage can improve *resiliency* (the ability to withstand and recover rapidly from disruption) by helping to restart generation after an outage, a process known as *black start*, or by providing backup power during prolonged outages.<sup>16</sup>

---

<sup>15</sup>GAO, *Energy Storage: Information on Challenges to Deployment for Electricity Grid Operations and Efforts to Address Them*, GAO-18-402 (Washington, D.C.: May 24, 2018).

<sup>16</sup>Black start, voltage support, and frequency regulation are referred to as *ancillary services*.

**Figure 6: Examples of energy-storage applications on the electricity grid**

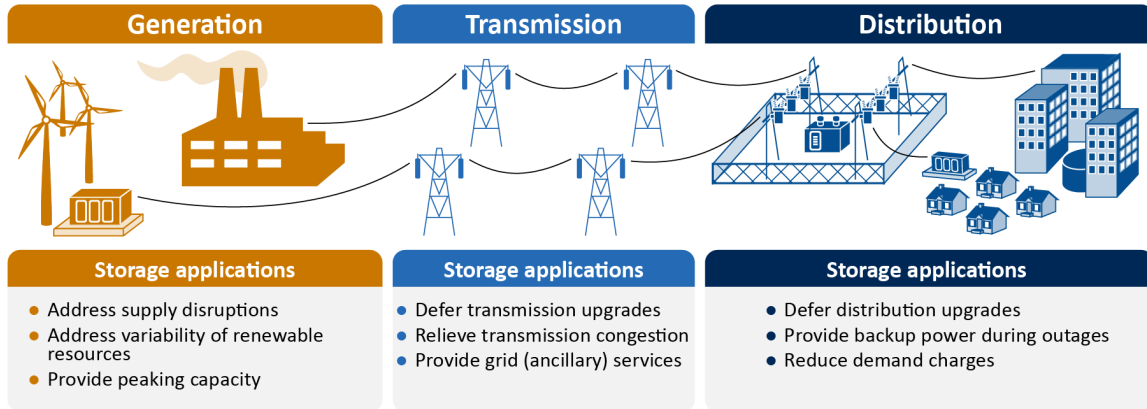

Source: GAO illustration based on studies and documents. | GAO-23-105583

Another benefit of energy storage technologies is potentially enabling the growth of variable renewable energy generation. Variable renewable generation technologies—such as solar and wind—have variable and uncertain output, unlike the dispatchable sources, such as coal, natural gas, or nuclear energy, used for the majority of U.S. electricity generation. Energy storage growth is being driven, in part, by variable renewable generation technology growth. Such technologies could, in the future, supplement or replace traditional resources, which operate on an almost continuous basis. This may require a large increase in the amount of available energy storage to meet electricity demand and maintain reliable grid operations. Energy storage technologies can absorb excess energy during times of high production. This capability can reduce curtailments—when generators must reduce output because additional energy is not needed. Storage technologies could then release the stored energy during high demand periods, or when variable generation technologies are not producing energy. See figure 7 for an example of curtailed wind, demonstrating energy variability on an example grid. However, the amount of

storage employed with variable energy generation technologies will depend on the costs and benefits of each technology relative to other available options, along with other factors, such as state decarbonization policies.

**Figure 7: Hypothetical example of curtailed wind energy on a grid using simulated data**

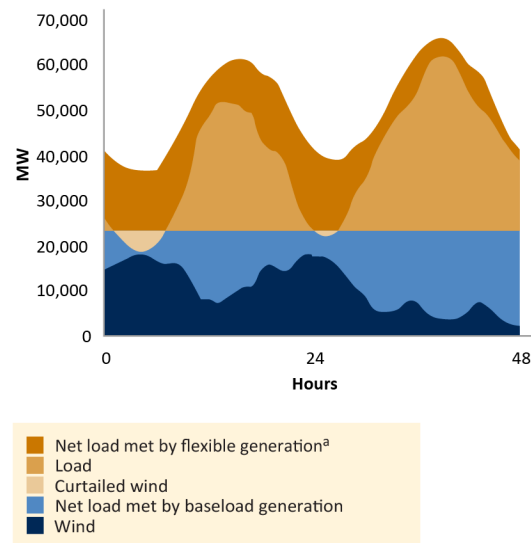

Source: National Renewable Energy Laboratory. | GAO-23-105583

<sup>a</sup>Flexible generation is generation that is designed to respond to changes in electricity supply and demand.

## 1.4 History of energy storage technologies

For the first century of the U.S. grid, energy storage in the United States has provided a small fraction of the electricity system’s total capacity—less than 3 percent, according to the National Renewable Energy Laboratory. It consisted of pumped hydroelectric storage projects, which pumped water to higher-elevation reservoirs when demand was low, typically at night, and released it to generate electricity when demand increased. The first pumped hydroelectric storage facility was built in the 1920s, and over 85 percent of the United States’ pumped hydroelectric energy storage capacity was built between 1960 and 1985. No new facility has been built since 2012. These facilities provide multiple grid services. For example, through arbitrage; *firm capacity*, which is power that can be made available at all times, during a certain period even under adverse conditions; and ancillary services such as black start and frequency regulation.

According to a National Renewable Energy Laboratory report, prior to the development of low-cost, efficient gas turbines, utilities relied on oil- and gas-fired steam turbines along with hydroelectric dams.<sup>17</sup> There were dramatic oil and natural gas price increases in the 1970s, coupled with supply concerns.

Subsequently, Congress passed the Powerplant and Industrial Fuel Use Act of 1978, a law restricting the use of oil and gas in new power plants. These restrictions led utilities to evaluate pumped hydroelectric and other storage technologies as alternatives to fossil fuel-powered plants. Energy storage was used to store energy from coal produced at off-peak times, and to replace natural gas energy generation at on-peak times, so that the units remained at the optimal output as system load varied. Many energy storage facilities were planned and built in response to the prospect of very low cost *baseload power*—electricity produced continuously and at a steady rate—provided by nuclear and coal plants.

By the mid- to late-1970s, batteries, flywheels, and other storage technologies were in development.<sup>18</sup> However, these technologies could not match pumped hydroelectric storage’s ability to provide longer duration energy storage.<sup>19</sup> This led researchers to identify uses for technologies with 1 to 6 hour storage durations. Energy storage technology interest waned in the 1980s because of a dramatic reduction in natural gas prices, increased natural gas turbine efficiency, and the 1987 repeal of restrictions on the use of natural gas. Further, according to a Sandia National Laboratories report, pumped hydroelectric storage

---

<sup>17</sup>National Renewable Energy Laboratory, *The Role of Energy Storage with Renewable Electricity Generation*, NREL/TP-6A2-47187 (Golden, Colorado; January 2010).

<sup>18</sup>Historically, batteries had some electricity system use. For example, in the 1880s lead-acid batteries provided night-time electricity in private New York City electricity systems. These batteries were used to supply electricity during periods of high demand and store energy when demand was low for later use.

<sup>19</sup>For the purposes of our report we are defining longer duration energy storage as 10 or more hours. According to a National Renewable Energy Laboratory study, multiple sources have defined long duration energy storage as being anywhere from a few hours to multiple days, with most defining long duration energy storage as 4 or more hours. This study further states that energy storage duration is typically described by the number of hours a storage device can provide continuous output at its rated capacity. National Renewable Energy Laboratory, *The Challenge of Defining Long-Duration Energy Storage* NREL/TP-6A40-80583 (Golden, CO: 2021).

capacity growth stalled in this time period because of opposition on environmental grounds, among other factors.<sup>20</sup> These factors resulted in limited energy storage technology deployment between 1990 and 2010. Energy storage technology interest was renewed in the early 2000s, according to the National Renewable Energy Laboratory, owing to factors such as natural gas price volatility, and the creation of wholesale markets. These markets included products that provided storage an opportunity to compete with other technologies and demonstrate its potential value.

### 1.5 Factors affecting economic viability

Economic factors and other constraints may impact energy storage technology use on the grid. Energy storage technologies are increasingly used on the grid because of two main economic factors: declining cost (especially for lithium-ion batteries) and the increasing use of variable energy sources such as wind and solar. The energy capacity cost of large-scale lithium-ion batteries has declined rapidly in recent years (see fig. 8), in part because of development of this technology for the electric vehicle market.

**Figure 8: Total installed costs per kilowatt-hour (energy capacity) of large-scale battery storage systems from 2015-2019**

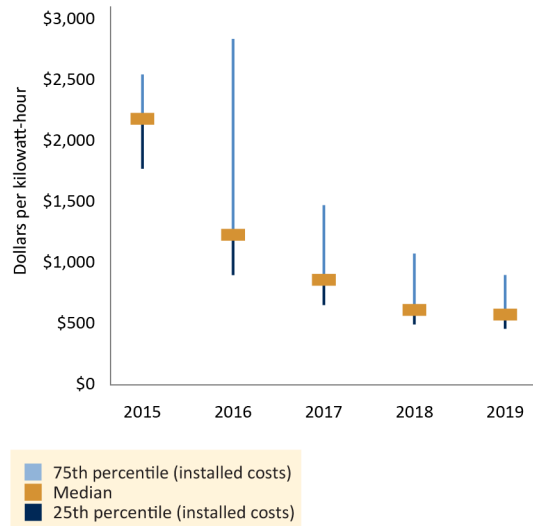

Source: Energy Information Administration. | GAO-23-105583

Note: The Energy Information Administration developed this image from Form 860 data.

Storage technologies can provide a variety of services on the electricity grid, including arbitrage, ancillary, and transmission deferral. The need for some of these services has increased along with the rapid growth in variable energy sources, in turn increasing the potential for investments in storage technologies to produce value for their owners. Some of these services are:

- **Arbitrage.** Solar and wind power have low operating costs compared with power from a natural gas combustion turbine, so storage of excess energy from solar or wind sources can reduce electricity costs by reducing the need to use electricity from gas turbines. For example, in

<sup>20</sup>Sandia National Laboratories, *DOE/EPRI Electricity Storage Handbook in Collaboration with NRECA SAND2015-1002* (Albuquerque N.M., and Livermore, CA; 2015).

California, where solar energy has grown rapidly, energy storage could charge during the early afternoon when solar energy is plentiful then discharge in the evening after the sun sets.

- **Ancillary services.** As the share of electricity from solar and wind generation facilities increases, the need for such services grows because supply is more variable. Some energy storage technologies, for example, are particularly well-suited for frequency regulation services because they can very quickly inject electricity onto the grid by discharging or remove it from the grid by charging.<sup>21</sup>

The ability of storage to defer investments in expanding transmission capacity can also be an attractive proposition for electric utilities. Transmission lines can be expensive and time consuming to build. Energy storage technologies can circumvent or delay costly transmission upgrades. For example, placing storage in an area with insufficient transmission capacity may allow the existing infrastructure to meet growing demand and delay the need to install additional transmission lines.

Several factors inherent to energy storage technologies will affect their economic feasibility and growth opportunities. For example, the speed with which a storage technology can respond to changes in demand and supply makes it attractive for

providing ancillary services. Lithium-ion batteries can respond in 1 second, a capability that has contributed to their rapid capacity growth on the grid. Another factor is duration—the length of the time that the storage facility can supply electricity. Other factors affecting the adoption of different types of storage include energy density, scalability, efficiency, materials cost, and safety.<sup>22</sup>

Some states are employing various policies to encourage energy storage technology deployment including incentives, setting aside research and development funds, and establishing procurement targets. A key reason these resources may be increasing on the grid in some parts of the U.S. is government incentives. These incentives include tax credits and the adoption by many states of requirements for utilities to get a minimum percentage of their electricity from renewable sources. The latter requirement is known as a renewable portfolio standard. According to the Energy Information Administration (EIA), as of November 2022, 29 states have a binding renewable portfolio standard, and seven others states have renewable portfolio goals. New storage may be deployed based on its ability to provide a cost effective alternative to or supplement to technologies that provide grid reliability services. The increase in variable sources of electricity such as wind and solar has also caused storage to grow. According to EIA, in 2020 renewables—such as wind, hydroelectric, and solar energy—produced

---

<sup>21</sup>Electric systems in North America primarily use alternating current, which reverses direction a certain number of times per second. In the U.S., it reverses with a *frequency* of 60 cycles per second (hertz). Deviations from 60 hertz indicate a mismatch between electricity supply and demand and can cause electric system failures.

<sup>22</sup>Energy density is the amount of energy that a storage system can store with respect to its weight or volume.

approximately 21 percent of the electricity generated in the U.S., surpassing coal and nuclear, to be the second most prevalent source of electricity generation. The total U.S. electricity generation portfolio's renewable resource contributions are expected to grow substantially over the next 30 years.

As the share of U.S. energy generation from variable renewable energy technologies grows, longer duration energy storage may be important in ensuring that electricity is available to consumers at all times. However, need may vary based on region, renewable energy use, existing energy storage technology deployment, and economic factors. Further, the availability of longer-duration energy storage may impact variable renewable energy adoption. However, as of 2021, the National Renewable Energy Laboratory reported that at least in some locations, there was no inherent need for longer duration energy storage to ensure that electricity is available to consumers at all times.<sup>23</sup>

Another factor that may affect the adoption of storage technologies is related to how some of the models used for grid planning may not fully capture the role of storage on the grid. Grid planners and operators use models to forecast future demand. These predictions are used to build and maintain the resources needed to ensure reliable electricity services at reasonably low costs. Some of the models that utility planners use may need to be updated to reflect the role that storage plays on the grid and the costs and benefits associated with storage

investments and operations. However, energy storage adds complexity to the modeling because it can be both a generator and a load. This characteristic makes it more difficult for planners to model the costs of storage and the value a new storage investment would bring to the grid.

## 1.6 Legal and regulatory considerations

Responsibility for regulating the U.S. power industry is divided among states and the federal government. As defined in the Federal Power Act, FERC's jurisdiction over the U.S. power industry is generally limited to the "transmission of electric energy in interstate commerce and to the sale of electric energy at wholesale in interstate commerce."<sup>24</sup> Intrastate transmission and distribution of electricity, as well as intrastate sales of electricity are largely regulated by the states. State regulators generally approve utility investments in generation and distribution, the rates retail customers pay, and how those rates are set.

In many regions of the country, RTOs or ISOs serve as grid operators by managing regional networks of electric transmission lines and also operate wholesale electricity markets to buy and sell services needed to maintain a reliable grid. These RTOs or ISOs are responsible for developing and implementing market rules, approved by FERC, that provide the framework for the design and operation of wholesale electricity markets. FERC is responsible for overseeing RTO development

---

<sup>23</sup>National Renewable Energy Laboratory, *The Challenge of Defining Long-Duration Energy Storage*.

<sup>24</sup>16 U.S.C. § 824(b). The Federal Power Act also authorizes FERC to license and inspect hydropower projects, including pumped hydroelectric storage. 16 U.S.C. § 797.



and operation of markets to ensure that wholesale electric rates are “just and reasonable” and not “unduly discriminatory or preferential.”<sup>25</sup> In this regulatory role, FERC issued a final rule in 2007, Order No. 890, requiring public utilities to consider non-transmission alternatives in local transmission planning.<sup>26</sup> FERC extended that requirement to regional transmission planning in Order No. 1000, which FERC issued in 2011.<sup>27</sup> In 2018, FERC issued Order No. 841 to remove barriers to the participation of electric storage resources in the capacity, energy, and ancillary services markets operated by RTOs and ISOs.<sup>28</sup>

Beyond its regulatory role, the federal government supports energy storage research and development. For example, the United States Energy Storage Competitiveness Act of 2007 tasked DOE with conducting basic and applied research programs on energy storage systems, including stationary applications and electricity transmission and distribution technologies, and called on DOE to establish energy storage research centers.<sup>29</sup> Most

recently, the 2021 Infrastructure Investment and Jobs Act, included a \$505 million appropriation for DOE energy storage demonstration projects for fiscal years 2022 to 2025, and tasked DOE with several energy storage related efforts.<sup>30</sup> The Act requires DOE to conduct a study of codes and standards for the use of energy storage systems across sectors, in part to identify barriers and foster collaboration, and increase conformity relating to the use of emerging energy storage technology. The Act also establishes an advanced energy manufacturing and recycling grants program, requires DOE to support energy storage demonstration projects to address second-life applications of electric vehicle batteries as aggregated energy storage installations for the grid, and requires the EIA to develop a plan for updating the capabilities of the National Energy Modeling System including with respect to demand response and improved representation of energy storage.

The federal government has also provided tax incentives for commercial investment and

---

<sup>25</sup>While major sections of the country operate under more traditional market structures, two-thirds of the nation’s electricity is served in ISO or RTO regions. FERC does not regulate wholesale sales of electricity in the ISO market in Texas (the Electric Reliability Council of Texas) which is separate from the rest of the U.S. grid. FERC derives this authority from sections 205 and 206 Federal Power Act—the primary federal legislation governing the wholesale transmission and sale of electric power. 16 U.S.C. §§ 824d-824e. In addition, the Energy Policy Act of 2005 directed FERC to certify an electric reliability organization, which FERC designated to be the North American Electric Reliability Corporation (NERC) in 2006. Pub. L. No. 109-58, § 1211, 119 Stat. 594, 941-46 (codified at 16 U.S.C. § 824o). NERC is responsible for conducting reliability assessments and developing and enforcing mandatory standards, approved by FERC, to provide for the reliable operation of the bulk power system.

<sup>26</sup>Preventing Undue Discrimination and Preference in Transmission Service, 72 Fed. Reg. 12,266 (Mar. 15, 2007).

<sup>27</sup>Transmission Planning and Cost Allocation by Transmission Owning and Operating Public Utilities, 76 Fed. Reg. 49842 (Aug. 11, 2011).

<sup>28</sup>Electric Storage Participation in Markets Operated by Regional Transmission Organizations and Independent System Operators, 83 Fed. Reg. 9580 (Mar. 6, 2018). FERC defines an electric storage resource as “a resource capable of receiving electric energy from the grid and storing it for later injection of electric energy back to the grid.” 18 C.F.R. § 35.28(b)(9). In May of 2019, FERC issued Order No. 841-A, generally affirming and providing clarification on various aspects of Order No. 841. Electric Storage Participation in Markets Operated by Regional Transmission Organizations and Independent System Operators, 84 Fed. Reg. 23902 (May 23, 2019).

<sup>29</sup>Pub. L. No. 110-140, § 641, 121 Stat. 1492, 1688-94.

<sup>30</sup>Pub. L. No. 117-58, Div. J., Tit. III, 135 Stat. 429, 1376-77 (2021). These energy storage demonstration projects were initially authorized under the Energy Act of 2020, Pub. L. No. 116-260, Div. Z, § 3201, 134 Stat. 2418, 2517-25.

development, such as the new and expanded tax credits provided in the Inflation Reduction Act of 2022, which include:

- Expanding eligibility for the *energy credit* to include standalone energy storage technology with a minimum capacity of five kilowatt-hour.<sup>31</sup> Prior to the Act, eligibility was generally limited to energy storage systems colocated with qualifying generation facilities.
- Creating the *advanced manufacturing production credit* for domestic production and sale of qualifying components, which includes certain battery components and critical minerals.<sup>32</sup>

---

<sup>31</sup>Pub. L. No. 117-169, § 13102, 136 Stat. 1818, 1913-22. The energy credit is an investment tax credit for investment in qualifying renewable energy project, in which qualifying investors could claim a tax credit up to 30 percent of their project's capital costs. 26 U.S.C. § 48. The Inflation Reduction Act of 2022 also extended the investment tax credit through 2032 at 30 percent, phasing down to 26 percent and 22 percent in 2033 and 2034, respectively. The Act also created the Clean Electricity Investment Credit, which is applicable to zero emissions energy storage technology smaller than 5MW.

<sup>32</sup>Pub. L. No. 117-169, § 13502, 136 Stat. 1818, 1971-81 (codified at 26 U.S.C. § 45X). The amount of the advanced manufacturing tax credit depends on the eligible component.

## 2 Utility-Scale Energy Storage Technologies

Pumped hydroelectric storage, lithium-ion batteries, other battery types including flow batteries, compressed air energy storage, and flywheels, among other technologies, can be used on the grid at utility scale.<sup>33</sup> Pumped hydroelectric storage is well established on the grid, and lithium-ion battery usage has increased dramatically in the past 5 years. An expert told us that the U.S. needs an all-of-the-above approach for the scale of energy storage deployment necessary to meet future grid demands. Different technologies can provide different storage durations. It is not clear, however, what technologies besides pumped hydroelectric storage and compressed air energy storage will be used to support the potential need for longer-duration energy storage (10 or more hours of continuous discharge). Energy storage technologies can also have different applications

### 2.1 Multiple storage technologies are available

According to EIA data for 2021, of the technologies we reviewed, there was nearly

28,000 MW of storage capacity—on a net summer capacity basis—installed on the U.S. electricity grid.<sup>34</sup> Pumped hydroelectric storage accounted for over 80 percent of this capacity, and lithium-ion batteries accounted for nearly 17 percent. Other technologies represent approximately 1 percent of total grid energy storage capacity. See fig. 9 for the breakdown of these technologies.

As previously discussed, the economic feasibility and growth opportunities of energy storage technologies depend on various factors. These factors include energy density, scalability, efficiency, materials cost, and discharge duration times, among others. According to one stakeholder, building new energy storage projects could cause electricity rates to increase by 5 or 8 percent. However, rates are likely to increase in any case, because existing fossil fuel facilities are 40 to 50 years old, so new facilities will be required and costs passed on to customers, according to this stakeholder.

---

<sup>33</sup>We do not discuss concentrated solar thermal energy for this report because it cannot take energy from the grid, or hydrogen because it was not sufficiently established during our review.

<sup>34</sup>For the purposes of this report, unless otherwise noted, all MW of capacity reflect a net summer capacity basis, as reported by EIA.

**Figure 9: Percent of utility-scale energy storage in operation by technology type**

For facilities in operation on the U.S. electricity grid at the end of 2021 with at least 1 MW of net summer capacity.

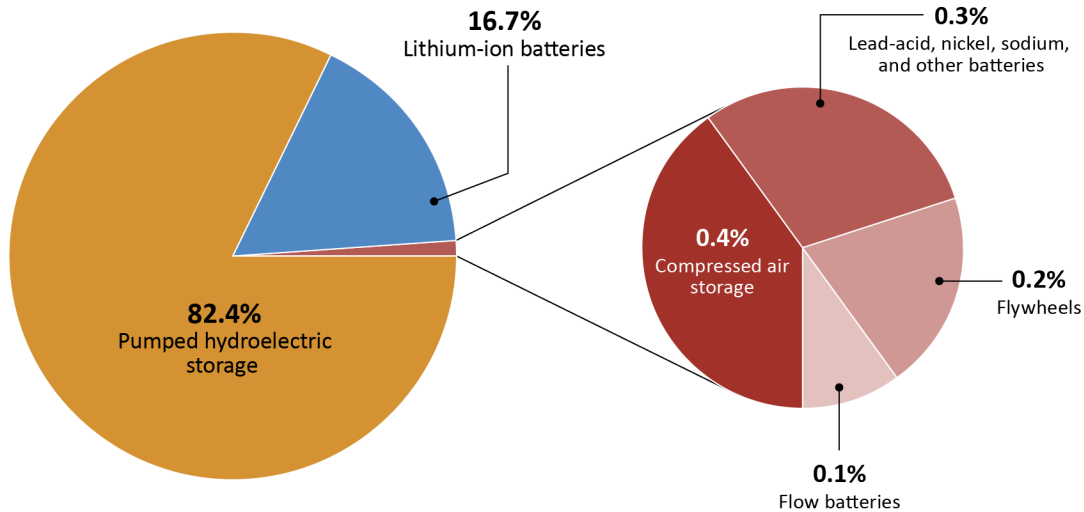

Source: Energy Information Administration data. | GAO-23-105583

Note: The percentages in the figure are approximate and add up to more than 100 percent because of rounding.

Note: According to the Energy Information Administration, net summer capacity is the maximum output, commonly expressed in megawatts (MW), that generating equipment can supply to system load, as demonstrated by a multi-hour test, at the time of summer peak demand (June 1 through September 30).

### 2.1.1 Pumped hydroelectric storage

Pumped hydroelectric storage is an established technology that works by pumping water from a lower reservoir to a higher reservoir and later releasing it through turbines to generate electricity (see the pumped hydroelectric storage vignette below). It represents more than 80 percent of U.S. energy storage capacity, with 40 plants in the U.S., providing more than 23,000 MW of

net summer capacity as of 2021, according to EIA data. Some existing U.S. facilities have been upgraded and expanded in order to increase their storage capacity, according to officials. Most pumped hydroelectric storage facilities were designed for one cycle of pumping and generation per day, but use has shifted to more cycles per day because of the increasing use of variable energy sources. A stakeholder we interviewed said it recently refurbished its facility to store excess renewable energy.

# Pumped hydroelectric storage

## Pumped hydroelectric storage plant configuration

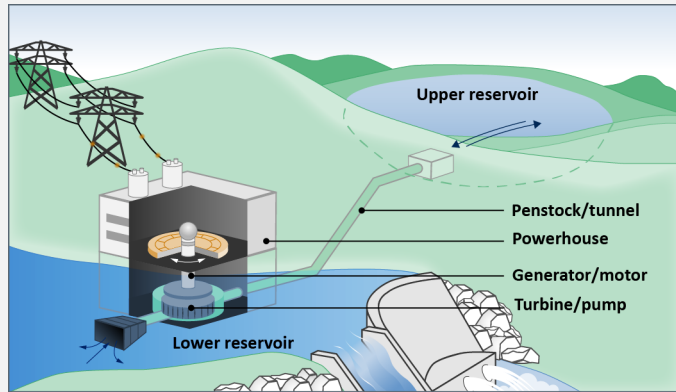

Source: Department of Energy. | GAO-23-105583

**Pumped hydroelectric storage** uses electricity to pump water from a lower to an upper reservoir. The water is later released through a turbine to generate electricity when needed. It has specific siting challenges.

### Attributes

**Estimated cost of an installed system**<sup>35</sup>: \$263 per kilowatt-hour, for a 100 megawatt, 10-hour system

**Round trip efficiency**<sup>36</sup>: 0.80

### Maturity

Pumped hydroelectric storage has been operating in the U.S. since the 1920s. According to agency officials, over the last 10 years, improved controls have enhanced its ability to perform frequency regulation, increased its accuracy in ramping up power output, and made facilities less prone to component wear and tear.<sup>37</sup>

### Applications

Facilities can provide grid reliability services such as frequency regulation and black start—the ability to restart generation after an outage. Agency officials said pumped hydroelectric storage is a proven longer duration energy storage technology. System response time varies by facility. Some can ramp up to full generation in as little as 90 seconds.

### Capacity and growth

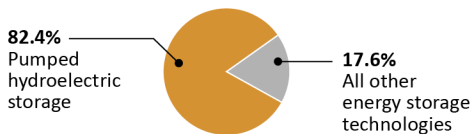

As of December 31, 2021, there were over 23,000 megawatts of pumped hydroelectric storage in the U.S., amounting to over 80 percent of total energy storage capacity. Most pumped hydroelectric facilities in the U.S. were built between 1960 and 1990. No new facilities have been built since 2012.

Source: GAO analysis. | GAO-23-105583

### Lifetime

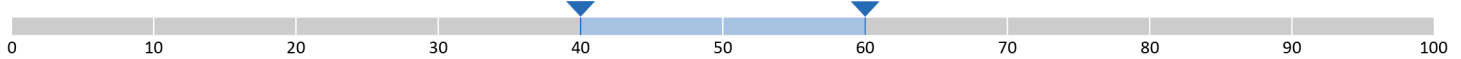

Source: GAO analysis. | GAO-23-105583

Agency officials said facilities have 40 to 60 year lifetimes. With upgrades and refurbishments, lifetimes can exceed 100 years. This long lifetime differentiates pumped hydroelectric storage from technologies with shorter lifetimes, like batteries.

Source: GAO analysis; GAO and petovarga/stock.adobe.com (header). | GAO-23-105583

<sup>35</sup>Pacific Northwest National Laboratory for the U.S. Department of Energy, *2022 Grid Energy Storage Technology Cost and Performance Assessment* (Aug 2022). Cost estimates and performance information from this report reflect the derived approximate value based on available data and conversations with technology developers and industry stakeholders, literature, commercial datasets, and reported storage costs for systems deployed across the U.S.

<sup>36</sup>Round trip efficiency is the percentage of electricity put into storage that is later retrieved.

<sup>37</sup>Frequency regulation helps balance differences between demand and load on the electric grid. Ramping up power quickly is useful to change electricity output based on changes in electric demand and ancillary services.

As noted in chapter 1, pumped hydroelectric storage was historically used for generating electricity when demand increased. For the modern electricity grid it is used for tasks such as frequency regulation, arbitrage, and black start capacity. Pumped hydroelectric storage can provide additional arbitrage opportunities—for example, between weekdays and weekends—because it can discharge its stored energy for longer periods than lithium-ion batteries, which are more economical at shorter durations.

Pumped hydroelectric storage has two main technologies in use on the grid, with others being evaluated for use. *Open loop* systems use an existing body of water for the lower reservoir, upper reservoir, or both, and typically involve damming a naturally flowing water feature to create the lower reservoir. A *closed loop* system uses constructed reservoirs and requires a water source to fill the reservoirs. Officials told us about other technologies being explored. For example, *geomechanical* pumped storage injects water into an underground rock formation, where it is kept under pressure. When electricity is needed, the water is released to generate electricity. DOE officials have assessed at least 11 other potential technologies.<sup>38</sup>

Pumped hydroelectric storage has a number of advantages:

- **Low cost after installation.** Pumped hydroelectric storage facilities generally have the lowest energy storage capacity

---

<sup>38</sup>In addition to *geomechanical* pumped hydroelectric storage, DOE has investigated other potential technologies such as pumped hydroelectric storage using submersible pump-turbines and motor-generators, underground mine pumped hydroelectric storage, and high-density fluid pumped hydroelectric storage, among others.

cost—that is, the cost to store energy, typically measured in dollars per kilowatt-hour—among deployed technologies, according to one report.<sup>39</sup>

- **Mature technology.** Pumped hydroelectric storage has been in use since the 1920s and is a mature, well-established technology.
- **Grid resiliency and transmission benefits.** Pumped hydroelectric storage can provide resiliency benefits, such as black start. Such facilities can also store energy when transmission lines become overloaded.
- **Longer-duration energy storage.** Pumped hydroelectric storage can discharge energy for up to 16 hours as of June 2022, according to officials.
- **Arbitrage.** Providing arbitrage for cheap renewable production at off-peak times provides a benefit as the curtailments of solar and wind can be reduced.

Pumped hydroelectric storage has a number of limitations:

- **High capital costs, market uncertainty, site specific design, and regulatory hurdles before installation.** New facilities are large construction projects that can cost hundreds of millions to billions of dollars and take 4 to 5 years to construct. In addition, the FERC permitting process takes approximately 5 years. The large initial investment prolongs the payback

<sup>39</sup>Massachusetts Institute of Technology, *The Future of Energy Storage, An Interdisciplinary MIT Study* (Cambridge, MA: 2022).

period, so pumped hydroelectric storage may be slow to achieve economic breakeven. Operators face future market uncertainty and difficulty showing a successful value proposition—that is, all benefits and costs that are associated with an investment—according to officials. Agency officials told us that pumped hydroelectric storage facilities are site-specific to their geographic location. Developers must build custom turbines and generators depending on a site’s geographical features. One expert noted it is not possible to have pumped hydroelectric storage if a site is flat.

- **Unclear if further improvements to the core technology are possible.** Because it is a mature technology, little research and development is conducted for pumped hydroelectric storage.
- **Social acceptance.** Existing and planned pumped hydroelectric storage facilities may face social acceptance hurdles. For example, a community may not want a new large project nearby.
- **Potential environmental effects.** According to a report by Pacific Northwest National Laboratory, both *open loop* and *closed loop* systems present potential environmental effects for surface water, recreation, and other resources. The report concludes that the environmental effects must be assessed on a case-by-case basis and may be able to be mitigated.<sup>40</sup>
- **Safety considerations.** Building a large hydropower system requires high safety

standards during construction and while the system is in use to ensure the safety of personnel and equipment, according to a stakeholder and officials we interviewed. Additionally, there is the potential for artificial reservoirs to overflow or fail, which has public safety implications for residents and workers downstream of the reservoir. In 2005, for example, an upper reservoir failed at a pumped hydroelectric storage facility in Missouri, causing a substantial volume of water to flow rapidly downhill toward a state park.

Substantial amounts of pumped hydroelectric storage capacity could come online in the future, but it is unclear when. As of December 29, 2022, FERC had issued preliminary permits for 56 pumped hydroelectric storage projects totaling 46,446 MW of capacity. Another 56 projects totaling 38,130 MW are awaiting preliminary permits. Future pumped hydroelectric storage growth may be limited because of siting, environmental, regulatory, or monetary factors. Pumped hydroelectric storage has grown internationally, primarily in China, which may, in the future, have substantially more pumped hydroelectric storage than the U.S.

### 2.1.2 Lithium-ion batteries

Lithium-ion battery storage is growing the fastest of all utility-scale energy storage technologies we reviewed. Between 2020 and 2021, approximately 3,237 MW of additional capacity have come online, representing a 229 percent increase, according to EIA data.<sup>41</sup>

<sup>40</sup>Pacific Northwest National Laboratory, *A Comparison of the Environmental Effects of Open-Loop and Closed-Loop Pumped Storage Hydropower*, (April 2020).

<sup>41</sup>For the purposes of this report, we are only reporting utility-scale installations of 1 MW or greater, according to EIA data.

As of 2021, according to EIA, over 10,000 MW of battery storage—chiefly lithium-ion batteries—have been planned for construction between 2021 and 2023.

Grid operators and utilities use lithium-ion batteries for nearly every energy storage application, but officials told us they are not well suited for longer-duration energy storage applications. For example, lithium-ion batteries can be used to store excess renewable energy generation and as a black start resource. However, one expert noted that lithium-ion batteries require grid-forming inverters to be used as a black start resource. They can also assist with frequency regulation because they can respond quickly, sometimes as quickly as 1 second. The lithium-ion battery vignette below provides an overview of the technology.



# Lithium-ion battery

## Lithium-ion battery configuration

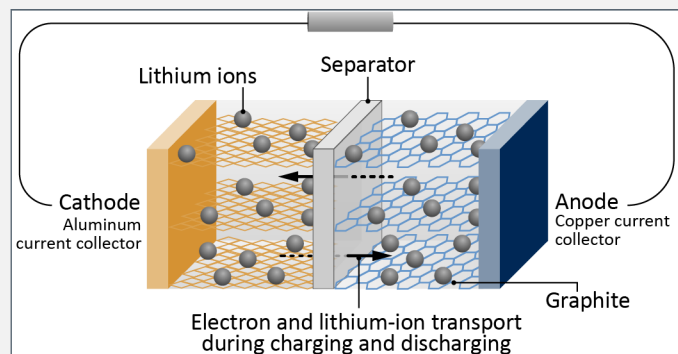

Source: GAO. | GAO-23-105583

**Lithium-ion batteries** operate by a reversible process where lithium ions move from the negative to the positive electrode during discharge to produce electricity. When charging, external power reverses the process, causing lithium ions to move from the positive to the negative electrode. The discharge and charge cycles allow lithium-ion batteries to quickly release and then receive electricity.

## Attributes

**Estimated cost of an installed system**<sup>42</sup>: \$385 to \$435 per kilowatt-hour for a 100 megawatt, 4-hour system; \$356 to \$405 per kilowatt-hour for a 100 megawatt, 10-hour system.

**Round trip efficiency**<sup>43</sup>: 0.86

## Maturity

Lithium-ion batteries were first commercialized in 1991. They have been adopted for utility-scale use because of their use in consumer products and electric vehicles.

## Applications

Lithium-ion batteries may be suitable for any grid-scale energy application, but face challenges providing longer-duration services. Further, two experts said such batteries are less cost effective for longer-duration applications. Lithium-ion batteries have a one second response time which is limited by the system used to move energy from the battery to the grid.

## Capacity and growth

Summer capacity (MW)

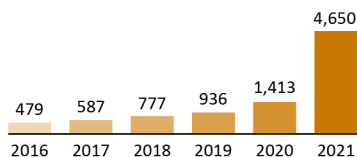

Source: GAO analysis. | GAO-23-105583

Lithium-ion battery capacity is growing rapidly in the United States. As of December 31, 2021, there were 4,650 megawatts of lithium-ion storage capacity. The Energy Information Administration projected in August 2021 that an additional 10,000 megawatts of battery capacity would be added between 2021 and 2023, most of which is lithium-ion.

## Lifetime

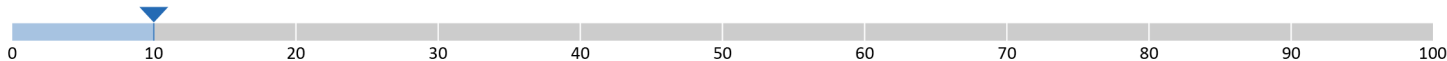

Source: GAO analysis. | GAO-23-105583

Lithium-ion battery performance declines with use, losing 0.5 percent round trip efficiency annually. Lithium-ion batteries have a lifetime of approximately 10 years, after which maintenance and battery replacement are needed to keep the system operational.

Source: GAO analysis; GAO and petovarga/stock.adobe.com (header). | GAO-23-105583

<sup>42</sup>Pacific Northwest National Laboratory for the U.S. Department of Energy, *2022 Grid Energy Storage Technology Cost and Performance Assessment* (Aug 2022). Cost estimates and performance information from this report reflect the derived approximate value based on available data and conversations with technology developers and industry stakeholders, literature, commercial datasets, and reported storage costs for systems deployed across the U.S.

<sup>43</sup>Round trip efficiency is the percentage of electricity put into storage that is later retrieved.

EIA's 2021 Battery Storage Market Trends report forecasted that battery storage systems colocated with power generation plants would be the most frequently implemented energy storage technology from 2021 to 2023.<sup>44</sup> According to this report, 80 percent of colocated battery storage power capacity that is scheduled to come online by 2023 will be paired with solar generation facilities. Most of this new battery storage colocated with solar will be in California and Southwestern states such as Arizona, New Mexico, and Nevada. Batteries may also be placed with existing power plants—so-called brownfield systems—that offer further cost advantages. Colocating battery storage systems with existing power plants that are slated for retirement may reduce storage costs and help relieve interconnection challenges. See chapter 3 for a discussion of interconnection challenges.

Lithium-ion batteries have a number of advantages:

- **High energy density.**<sup>45</sup> Lithium-ion batteries can store more energy in a smaller footprint and with less weight than other energy storage technologies.

- **Modular and scalable.** Lithium-ion batteries can be placed at many locations and fit onto many footprints.
- **Fast response times.** Lithium-ion batteries have fast response times, so they may be suitable for nearly any energy storage application, especially ancillary services.

Lithium-ion batteries have a number of limitations:

- **Thermal runaway.** Thermal runaway is one of the primary risks related to lithium-ion batteries. There have been a number of thermal runaway events leading to fires caused by lithium-ion battery systems.<sup>46</sup> These events involve uncontrollable self-heating by the battery. As we have previously reported, lithium-ion batteries may also pose a fire risk if lithium recovery is attempted at end-of-life.<sup>47</sup>
- **Unable to design for power or energy independently.** Unlike some other technologies, such as flow batteries, lithium-ion battery systems cannot be designed to separately optimize power or energy.<sup>48</sup> By contrast, some flow batteries can be designed for specific applications

---

<sup>44</sup>U.S. Energy Information Administration, *U.S. Battery Storage Market Trends* (Aug. 2021).

<sup>45</sup>According to DOE's Office of Energy Efficiency & Renewable Energy website, energy density is the amount of energy a device can store with respect to its mass. Power density is the amount of power that can be generated by a device with respect to its mass. Using a swimming pool as an example, when draining a pool, energy density is similar to the size of the pool, while power density is comparable to draining the pool as quickly as possible.

<sup>46</sup>Thermal runaway is a phenomenon in which the lithium-ion battery cell enters an uncontrollable, self-heating state. In extreme cases, it can cause explosions and fires, if the thermal runaway events reach extremely high temperatures.

<sup>47</sup>*Critical Minerals: Building on Federal Efforts to Advance Recovery and Substitution Could Help Address Supply Risks*, GAO-22-104824 (Washington, D.C.: June 16, 2022).

<sup>48</sup>Lithium-ion batteries can be designed to fully discharge in minutes, which is useful for some power applications. They can also be designed to discharge over several hours, which is useful for some energy applications.

where power or energy capacity is optimized for respective use cases.

- **Longer-duration energy storage.** Lithium-ion batteries are not well suited for applications requiring storage beyond 10 hours, according to officials.
- **Supply chain and recycling concerns.** As we have previously reported, the U.S. relies heavily on imports of many minerals, such as cobalt and lithium, which are essential for manufacturing lithium-ion batteries.<sup>49</sup> Many pieces of the lithium-ion battery supply chain—that is, raw and processed materials, subcomponents, and batteries—come to the U.S. from other countries, primarily China. There are efforts to onshore additional battery production to the U.S. For example, as we have previously reported, the Infrastructure Investment and Jobs Act requires DOE to take various steps aimed at enhancing domestic supply chains and manufacturing for battery materials and advanced batteries.<sup>50</sup> In addition, the lithium-ion battery reuse and recycling market is nascent, according to a National Renewable Energy Laboratory report.<sup>51</sup> As we have previously reported, most critical minerals, such as rare earth elements, are not collected for recycling on a large scale, in part because of variations in recycling programs.<sup>52</sup> According to one stakeholder we interviewed, battery

recycle and reuse is a field that has not seen significant research. The stakeholder told us that electric vehicle batteries at their end-of-life could be repurposed and present a source of batteries for grid-scale energy storage systems.

Battery storage has grown more quickly in some regions than others and quickest in markets governed by ISOs or RTOs. These markets contain 74 percent of battery power capacity while representing 58 percent of total grid capacity, based on EIA 2019 data. Growth has occurred in the PJM Interconnection, an RTO, and California ISO territory, which together account for approximately half of utility scale battery storage power capacity. Lithium-ion battery storage growth in California is being driven in part by its state energy storage requirement, which requires investor-owned utilities to deploy 1,325 MW of energy storage by 2024.

Various types of lithium-ion batteries are in use or being considered for use on the grid. Lithium nickel cobalt aluminum oxide, lithium nickel manganese cobalt oxide, and lithium iron phosphate are among the chemistries in use for lithium-ion batteries as of 2022.<sup>53</sup> As we have previously reported, scientists are exploring how to replace critical elements in various components of lithium-ion batteries to improve their performance and safety

---

<sup>49</sup>GAO-22-104824.

<sup>50</sup>GAO-22-104824.

<sup>51</sup>National Renewable Energy Laboratory, *A Circular Economy for Lithium-Ion Batteries Used in Mobile and Stationary Energy Storage: Drivers, Barriers, Enablers, and U.S. Policy Considerations* (Golden, CO: February 2021).

<sup>52</sup>GAO-22-104824.

<sup>53</sup>Lithium nickel cobalt aluminum oxide-based batteries use lower cost nickel and aluminum compared to earlier lithium-ion batteries. Lithium nickel manganese cobalt dioxide-based batteries offer higher energy density and longer cycle life compared to earlier lithium-ion batteries. Lithium iron phosphate-based batteries offer low cost, better thermal stability, and do not contain resource-limited elements like cobalt, which make them attractive for grid energy storage applications.

while using more sustainable, widely available, and cost-effective materials.<sup>54</sup>

### 2.1.3 Other battery types

Multiple types of batteries are being evaluated for use on the grid, such as flow and metal-air batteries.<sup>55</sup> Flow batteries are used on the grid to shift peak demand, and assist with grid voltage control, among other uses. Some flow batteries can provide an attractive solution for applications of 6 hours or more, a duration length where they can compete with lithium-ion batteries. Flow batteries use separate chemical tanks containing energy storing chemicals and a special membrane to generate or receive electricity by circulating the chemicals between the two tanks. They can have multiple formulations and may contain energy storing chemicals that contain bromine, chromium, iron, vanadium, or zinc, among others. As of 2021, 17 MW of flow battery energy storage was in use on the grid, according to EIA data. Flow batteries are attractive because of their longer service life, 20 years in some cases, and potential for lower manufacturing costs. However, flow batteries are not as mature as lithium-ion batteries and prices of key chemicals that may be used in their manufacture, such as vanadium, have been volatile or costly. One expert noted that the safety of such batteries has not been sufficiently studied. According to a study by the Massachusetts Institute of Technology Energy Initiative, flow batteries account for less than 1.5 percent of energy storage systems under development, mainly

because of high chemical costs, and according to one expert, a lower round-trip efficiency.<sup>56</sup> The flow battery vignette below provides an overview of the technology.

---

<sup>54</sup>*Science & Tech Spotlight: Advanced Batteries*, GAO-23-106332 (Washington, D.C.: Dec. 8, 2022).

<sup>55</sup>Sodium, nickel, and lead-acid batteries are among the other battery technologies that are in use on the grid.

<sup>56</sup>Massachusetts Institute of Technology, *The Future of Energy Storage*.

# Flow battery

## Flow battery configuration

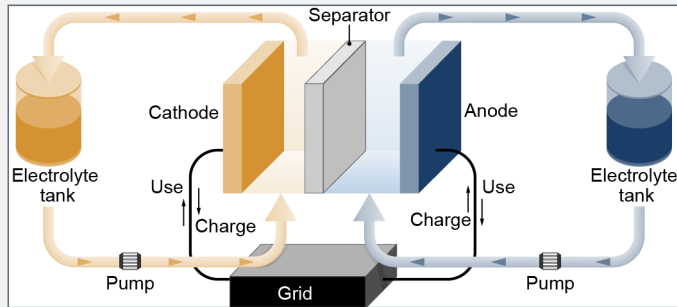

Source: GAO. | GAO-23-105583

**Flow batteries** contain separate tanks, one with a positively charged electrolyte, and another with a negatively charged electrolyte. An electrolyte is a medium that contains ions that allow an electric current to flow. The battery exchanges electrons through a membrane or separator as the electrolytes flow past each other. The system can generate or store electricity depending on the direction of a chemical reaction of the positively and negatively charged electrolytes.

## Attributes

**Estimated cost of an installed system**<sup>57</sup>: \$385 per kilowatt-hour for a 100 megawatt, 10-hour vanadium flow battery system

**Round trip efficiency**<sup>58</sup>: 0.68

## Maturity

Flow batteries were first developed in the 1970s and deployed at utility scale in 2016. Agency officials said flow batteries could be at the same level of development as lithium-ion batteries within 10 years, as of 2022. Over 100 companies were developing flow batteries with unique electrolyte chemistries, as of 2020.

## Applications

According to agency officials, flow batteries can perform longer-duration storage if equipped with adequately sized storage tanks. Flow batteries have a 1 second response time. This time is limited by the system used to move energy from the battery to the grid.

## Capacity

As of December 31, 2021, there were 17 megawatts of flow batteries on the U.S. electricity grid.

## Lifetime

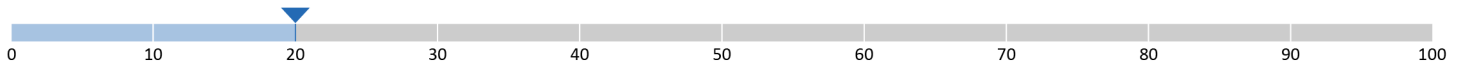

Source: GAO analysis. | GAO-23-105583

Flow batteries have a lifetime of approximately 20 years.

Source: GAO analysis; GAO and petovarga/stock.adobe.com (header). | GAO-23-105583

<sup>57</sup> Pacific Northwest National Laboratory for the U.S. Department of Energy, *2022 Grid Energy Storage Technology Cost and Performance Assessment* (Aug 2022). Cost estimates and performance information from this report reflect the derived approximate value based on available data and conversations with technology developers and industry stakeholders, literature, commercial datasets, and reported storage costs for systems deployed across the U.S.

<sup>58</sup> Round trip efficiency is the percentage of electricity put into storage that is later retrieved.

Flow batteries have a number of advantages:

- **Longer-duration energy storage.** Flow batteries could be used for longer-duration applications (i.e., 10 or more hours). Their physical separation of power and energy components allows them to be configured for a range of storage durations.
- **Safer than other batteries.** Flow batteries separate the chemicals that store energy into two tanks, making it harder to release the stored energy under nonstandard or emergency conditions. Additionally, flow batteries can use water-based energy storing chemicals (electrolytes), which are not flammable.
- **Manufacturing costs.** Flow batteries can have lower manufacturing costs and a longer service life than lithium-ion batteries.

Flow batteries have a number of limitations:

- **Price volatility.** Because of potential reliance on certain minerals, like vanadium, flow batteries may experience price volatility.
- **Environmental concerns.** Flow batteries may store large volumes of hazardous materials, which may pose hazards to human health or affect groundwater if released, according to officials.
- **Lower energy density compared to lithium-ion batteries.** Energy density—the amount of energy a battery can hold

in a given weight or size—can be one-tenth that of lithium-ion batteries. Flow batteries, therefore, may need to be about 10 times as large to hold the same amount of energy.

Other battery technologies are being considered for use on the grid, including metal air batteries. This technology has been in use in a basic form since the 1870s, mainly for small, disposable electronics such as hearing aids. It is attractive because of its very low cost per unit of energy storage compared to lithium-ion and flow batteries and a higher theoretical energy density than lithium-ion batteries, according to studies we reviewed. Metal air batteries have some of the lowest chemical costs of all rechargeable battery technologies. One type of metal air battery uses iron, which is plentiful and its use would avoid some of the supply chain concerns of other batteries, according to a stakeholder we interviewed. However, metal air batteries have a lower round trip efficiency—typically below 50 percent—and face other challenges.<sup>59</sup> By comparison, pumped hydroelectric storage has a round trip efficiency of 80 percent, and lithium-ion 86 percent. Because of their low materials costs, metal air batteries have been proposed as a candidate for longer-duration energy storage applications.

#### 2.1.4 Compressed air energy storage

Compressed air energy storage systems operate by using electricity to compress air into a reservoir. The system then heats and

---

<sup>59</sup>One expert noted metal air batteries may have a cycle life of 30 to 40 cycles. A lithium-ion battery may have a cycle life of over 2,000 cycles. However this is dependent on factors including battery chemistry.

releases the pressurized air through an expander or turbine to produce electricity. Some compressed air energy storage systems work in conjunction with natural gas combustion turbines that generate heat used during the air expansion process. A system using hydrogen gas in place of or in combination with natural gas has been developed. The air needs to be heated before energy can be extracted from it to generate electricity. The sole plant in the U.S., located in Alabama, serves mainly as an arbitrage resource. Newer types of facilities have been proposed, that retain the heat and re-use it in the electricity generation process, but no utility-scale systems have come online in the U.S. since 1991. See the compressed air energy storage vignette below for an overview of the technology.

# Compressed air energy storage

## Compressed air energy configuration

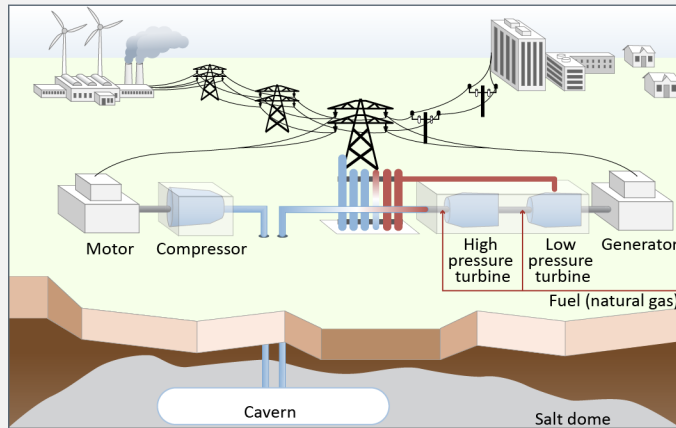

Source: Sandia National Laboratories. | GAO-23-105583

**Compressed air energy storage** operates by using electricity to compress air into a reservoir to store it. The compressed air is then heated and released through an expander or turbine to produce electricity. Some systems work in conjunction with natural gas or hydrogen combustion turbines that generate heat used during the expansion process. Others contain the heat fully within the system, according to one stakeholder.

### Attributes

**Estimated cost of an installed system**<sup>60</sup>: \$295 per kilowatt-hour for a 100 megawatt (MW), 4-hour system; \$122 per kilowatt-hour for a 100 MW, 10-hour system.

**Round trip efficiency**<sup>61</sup>: 0.52

## Maturity

The first compressed air energy storage plant was a 290 megawatt facility in Huntorf, Germany. It has been in operation since 1978. In 1991, a 110 MW plant went into operation in McIntosh, Alabama.

## Applications

Other than pumped hydroelectric storage, compressed air energy storage is the only energy storage technology available suitable for longer-duration energy storage, as of 2016. According to one stakeholder, it is best suited for storage durations of 6 hours or longer. Facilities can expand their storage duration by increasing their reservoir size, according to a stakeholder we interviewed. Facility response times from cold start range from 3 to 10 minutes. Traditional facilities require specific underground geologic formations, limiting where they can be built. A 1.75 MW advanced compressed air energy storage plant—that can be located in more common rock formations—was completed in 2019 in Ontario, Canada.

## Capacity for growth

As of December 31, 2021, there were 110 MW of compressed air energy storage on the electricity grid in the U.S. located in one facility. According to the Energy Information Administration, a 317 MW facility is scheduled to come online in Texas by 2025.

## Lifetime

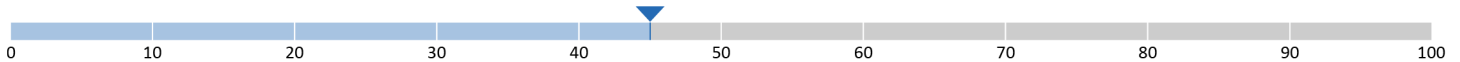

Source: GAO analysis. | GAO-23-105583

The Huntorf, Germany facility has been in operation for approximately 45 years, and the McIntosh, Alabama facility for 32 years.

Source: GAO analysis; GAO and petovarga/stock.adobe.com (header). | GAO-23-105583

<sup>60</sup>Pacific Northwest National Laboratory for the U.S. Department of Energy, *2022 Grid Energy Storage Technology Cost and Performance Assessment* (Aug 2022). Cost estimates and performance information from this report reflect the derived approximate value based on available data and conversations with technology developers and industry stakeholders, literature, commercial datasets, and reported storage costs for systems deployed across the U.S.

<sup>61</sup>Round trip efficiency is the percentage of electricity put into storage that is later retrieved.



There are two compressed air energy storage systems in use worldwide, a 290 MW facility in Germany and a 110 MW facility in Alabama. A 317 MW facility is scheduled to come online in Texas by the end of 2025. These types of systems tend to be large engineering projects. Additionally, compressed air energy storage requires specific geological formations, such as salt caverns. Newer system configurations have the potential for lower installed costs, higher efficiency, and faster construction time, according to a national laboratory report.<sup>62</sup> At least one newer system configuration can be sited in more common underground rock formations, according to a stakeholder we interviewed.

Compressed air energy storage has some advantages:

- **Longer-duration energy storage.** Compressed air energy storage is suitable for longer energy storage durations of 10 hours or more, and can, according to one expert, provide durations of 24-60 hours.
- **Low operating costs after installation.** One type of compressed air energy storage has some of the lowest per unit energy costs of any commercialized storage technology.

Compressed air energy storage has a number of limitations:

- **Geologic limitations.** Traditional systems are limited to specific underground geologic formations, known as salt caverns. Advanced systems could mitigate this limitation.
- **High capital costs before installation.** Similar to pumped hydroelectric storage, capital costs may be high because facilities can require large construction projects.
- **Safety concerns.** Compressed air energy storage facilities typically use natural gas. GAO has previously reported that natural gas may leak from facilities or gas may explode.<sup>63</sup>

### 2.1.5 Flywheels

Flywheels store energy in the form of a spinning mass. Electricity is used to accelerate the mass using a motor, and this spinning mass is later used to spin the motor as a generator to generate electrical power. Flywheels have short durations and are mainly used on the grid for fast response applications, such as frequency regulation, which keeps the grid's frequency stable by reconciling momentary differences between generation and load.<sup>64</sup> Grid operators also use flywheels to help lower carbon dioxide emissions and reduce wear and tear on fossil fuel-based generation technologies to avoid having to turn units on and off, which increases wear and tear. Similar to compressed air energy storage, flywheels

---

<sup>62</sup>Sandia National Laboratories, *DOE/EPRI Electricity Storage Handbook in Collaboration with NRECA* (NM and CA: September 2016).

<sup>63</sup>*Natural Gas Storage: Actions Needed to Assess Inspection Workload and Progress toward Safety Outcomes*, GAO-20-167 (Washington, D.C.: Oct. 16, 2019).

<sup>64</sup>In the U.S. the grid operates with alternating current, in which current reverses direction 60 times per second. Stable operation requires that this frequency remain at a consistent 60 cycles per second (Hertz).

have not received much commercial interest. There are four utility-scale facilities in use in the U.S. as of December 2021, according to EIA data. See the flywheel vignette below for an overview of the technology.



# Flywheel

## Flywheel configuration

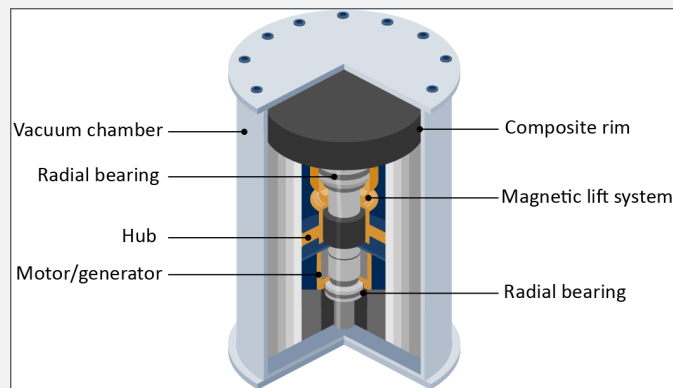

Source: Beacon Power. | GAO-23-105583

**Flywheels** store energy in the form of a spinning mass, known as a rotor, which is a heavy cylinder. The heavy cylinder is attached to a rotating shaft. Using electricity, a motor accelerates the cylinder, which converts electric power to spinning energy to store it. When the cylinder slows down, this action converts the spinning energy to electrical power for use on the grid.

## Attributes

**Estimated cost of an installed system**<sup>65</sup>: \$11,520 per kilowatt-hour for a 0.25-hour system

**Round trip efficiency**<sup>66</sup>: 0. 86

## Maturity

There are four flywheel facilities in the U.S. Stakeholders told us a 20 megawatt flywheel system, located in Stephentown, New York, has been operating on the grid since June, 2011. A 20 megawatt flywheel system was completed in Hazle Township, Pennsylvania, in July 2014.

## Applications

Flywheels have millisecond response times. They can deliver much more power than a comparable sized battery, but have much less total energy. Flywheels are effective at providing fast-response applications such as frequency regulation, which keeps the grid operating at a stable 60 cycles per second; and voltage support, which maintains consistent grid voltage and power quality and responds to power surges and declines.

## Capacity

As of December 31, 2021 there were 47 megawatt of flywheels in operation on the U.S. electricity grid.

## Lifetime

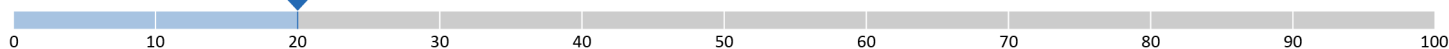

Source: GAO analysis. | GAO-23-105583

According to stakeholders, flywheels have lifetimes of approximately 20 years, with one stakeholder we interviewed estimating up to 25 years.

Source: GAO analysis; GAO and petovarga/stock.adobe.com (header). | GAO-23-105583

<sup>65</sup>Pacific Northwest National Laboratory for the U.S. Department of Energy, *Energy Storage Technology and Cost Characterization Report* (July 2019). Cost and performance data for this report were obtained from literature, conversations with vendors, and responses from vendors to questionnaires distributed by the research team.

<sup>66</sup>Round trip efficiency is the percentage of electricity put into storage that is later retrieved.

Flywheels have a number of advantages:

- **Fast response.** Flywheels can provide rapid response applications such as frequency regulation and power quality.<sup>67</sup> A rapid response application quickly injects or removes electricity from the grid to maintain normal grid function.
- **Long lifetime.** According to a DOE report, most flywheel developers estimate that the technology can perform more than 100,000 charge-discharge cycles.<sup>68</sup> Flywheel systems have lifetimes of approximately 20 years, with one stakeholder we interviewed explaining their systems were rated for up to 25 years.
- **High power density, especially when compared to lithium-ion batteries.** According to a DOE report, flywheels have 5 to 10 times the power density—the amount of power that can be stored and released by a device with respect to its mass—of batteries, meaning much less space is required to store a comparable amount of power.<sup>69</sup>

Flywheels have a number of limitations:

- **Limited range of applications.** Flywheels are suitable for a limited number of utility-scale applications and

have not seen commercial interest for uses besides fast-response applications.

- **Safety concerns.** Flywheels store a large amount of rotational energy, which could be destructive in a catastrophic failure, according to a report.<sup>70</sup> However, the safety of this technology is comparable to other industrial applications, if containment systems are used and other safety measures taken.

## 2.2 Different energy storage durations have different uses on the grid

Energy storage technologies have different uses depending on their durations, which can be from seconds to many days. The adoption of an energy storage technology may be impacted by system need and duration. Technologies such as lithium-ion batteries and flywheels can provide shorter duration capacity—from seconds to approximately 4 hours—that is useful for applications like arbitrage and frequency regulation. Technologies such as pumped hydroelectric storage and compressed air can provide longer duration capacity—10 or more hours—that is useful for shifting energy across one or more days—that is, shifting energy from off-peak to peak periods. Such technologies could also allow for longer arbitrage opportunities, such as from a weekday to the weekend. Battery

---

<sup>67</sup>Voltage support ensures that the grid's voltage is maintained within an acceptable range at all times. Power quality helps maintain consistent power on the grid, helping to avoid flaws such as power surges.

<sup>68</sup>Sandia National Laboratories, *DOE/EPRI Electricity Storage Handbook*.

<sup>69</sup>Sandia National Laboratories, *DOE/EPRI Electricity Storage Handbook*. The report also notes that there are practical limitations to the amount of energy that can be stored by a flywheel.

<sup>70</sup>Congressional Research Service, *Energy Storage for Power Grids and Electric Transportation: A Technology Assessment*, R42455 (Washington, D.C.: Mar. 27, 2012).

technologies can provide system benefits—for example, ensuring the grid is stable and more resilient to disruptions—and societal benefits—such as enabling a business or hospital to stay open during a disruption of other power sources. An expert told us that the U.S. needs an all-of-the-above approach for the scale of energy storage deployment necessary to meet future grid demands.

### 2.2.1 Shorter-duration energy storage is being installed on the grid

Energy storage technology use is increasing on the grid and tens of thousands of MW of energy storage are projected to be added to the grid by 2025, according to EIA data. As previously discussed, over 10,000 MW of battery storage have been planned for construction between 2021 and 2023. Most of the battery storage will likely be lithium-ion, which is primarily used for shorter duration applications of 4 hours or less.

Energy storage growth is driven primarily by increasing use of variable renewable energy technologies and state mandates. The U.S. power sector has seen an increase in variable renewable generation resources in the past several years and significant growth is anticipated in the future. Greater focus has also been given to renewable energy to address power system disruptions and reliability. These factors, along with cost declines and technological development, have heightened the potential role energy storage could play to ensure a reliable electricity grid.

Shorter duration energy storage technologies can provide a number of benefits for the grid. For example, battery storage with a 4 hour duration can help reduce peak demand and its associated costs. Short duration applications involve the injection or removal of power over short time scales (e.g., seconds up to approximately 4 hours) to maintain the stability of the power grid, with applications such as frequency regulation, as previously discussed.

### 2.2.2 Longer-duration energy storage may be needed, but its future is unclear

Longer-duration storage—that is, 10 or more hours of continuous energy storage output at a device’s rated capacity—may become necessary as more variable energy generation technologies, such as wind and solar, are added to the grid. However, between 2012 and 2022 there has been little deployment of additional grid-scale longer-duration technologies—that is, pumped hydroelectric storage and compressed air energy storage.

The need for storage with durations of 10 or more hours largely hinges on a future grid with a specific set of conditions including renewable energy deployment, regional load patterns, and other factors, according to National Renewable Energy Laboratory report.<sup>71</sup> In areas that rely heavily on wind and solar generation, longer-duration energy storage may be needed. Solar energy generation declines with cloud cover and ends at sunset, and

---

<sup>71</sup>National Renewable Energy Laboratory, *The Challenge of Defining Long-Duration Energy Storage*.

wind energy generation may vary throughout the day and seasonally. Other electricity sources, such as storage, are needed to fill the resulting shortfalls. In New England, for example, an expert told us that, under a future scenario with large amounts of renewables on the grid, several consecutive cold winter days of low wind and solar energy generation could create grid reliability concerns. Natural gas may not always be a substitute, because New England is pipeline constrained.

Technologies are in use for longer duration applications or being considered for use. Pumped hydroelectric storage and compressed air energy storage have been used on the grid for longer-duration energy storage. These technologies can be used because they have low costs per megawatt-hour, can discharge for over 10 hours, and have large capacities on the order of 1,000 MW.<sup>72</sup> However, these technologies cannot be used in all locations or for all applications and are expensive to build. Of the technologies we reviewed, flow batteries are being considered for longer-duration energy storage applications at grid scale, as of 2022. Flow batteries represent a very small percentage of the United States' energy storage portfolio, 17 MW or less than 1 percent as of 2021, but could be used for future longer-duration storage. Flow batteries can be tailored to provide longer or shorter storage durations depending on their tank size and the system needs.

DOE is exploring ways to make longer-duration energy storage cheaper and more attractive. In July 2021, for example, DOE announced its "Long Duration Storage Shot," which is part of its broader Energy Storage Grand Challenge Roadmap, the department's energy storage strategy. The plan aims to reduce the cost of grid-scale energy storage by 90 percent for longer-duration systems by 2030.

As of 2022, it is not clear which other technologies will emerge to fill longer-duration energy storage needs. Limited demand for services greater than 10 hours means that there has been little commercial interest in pursuing technologies besides pumped hydroelectric storage or compressed air energy storage to address longer-duration energy storage needs. A focus on ancillary services, lack of a longer-duration energy storage requirement, and other more established technologies are among the reasons for this lack of demand:

- **Focus on ancillary services.** Energy storage growth has focused on ancillary services, such as frequency regulation and ramping support, which typically require short duration energy storage applications. For example, as of May 5, 2022, ISO New England required market participants to demonstrate that reserves can be provided for only two hours of storage duration.
- **No longer-duration energy storage requirement.** California, for example, has provided incentives for longer-

---

<sup>72</sup>One expert noted that while it may be possible to build a 1,000 MW lithium-ion battery, doing so would not be cost effective.

duration demonstration projects, but its market does not have a need for 6 or more hours of duration as of January 2023, according to officials. According to a stakeholder we interviewed, there is no measurable market value for longer-duration energy storage and developers are only paid for the first hour of performance in today's ISO markets. In general, increasing a system's storage duration increases its cost. A study by the National Renewable Energy Laboratory suggests that the economic performance of energy storage declines beyond a certain duration, but this threshold duration depends on local grid and market conditions that can change over time.<sup>73</sup>

- **Other established technologies.** When longer durations of energy supply are needed, a grid operator or power company may use a gas peaker plant, or other short term peaking capacity generation source, instead of an energy storage technology. This may be based on costs or other considerations. According to a study, the use of natural gas for grid balancing may also make longer-duration energy storage noncompetitive.<sup>74</sup>

---

<sup>73</sup>National Renewable Energy Laboratory, *Storage Futures Study – The Four Phases of Storage Deployment: A Framework for the Expanding Role of Storage in the U.S. Power System* (Golden, CO: 2021).

<sup>74</sup>Massachusetts Institute of Technology, *The Future of Energy Storage*.

### 3 Several Challenges May Hinder Energy Storage Technology Development and Use

Based on our meeting of experts, interviews with agency and laboratory officials and stakeholders, and a review of literature, we identified five categories of challenges that may hinder energy storage technology development and use. The identified categories were (1) planning for storage technologies; (2) challenging regulatory environment; (3) existing codes and standards; (4) crosscutting challenges; and (5) valuing energy storage.

#### 3.1 Planning for storage technologies

Prior to deployment, plans need to be made for energy storage technologies. This planning is needed to integrate storage technologies with the existing grid and to accurately project each technology's costs and benefits. However, sufficient information is lacking to plan for storage on the grid, and planning activities are disjointed in some cases. Studies we reviewed and officials and stakeholders we interviewed identified four areas in which these issues present a challenge:

- **Predicting affordability, reliability, and resiliency.** To integrate storage technologies into the grid, operators need detailed information on each technology's costs and benefits. However, future costs for emerging technologies are difficult to predict. Furthermore, although storage can be used in a variety of ways to enhance electricity grid reliability and resilience, operators may not have the experience needed to integrate large amounts of storage capacity to perform these functions.

According to stakeholders we interviewed, it is difficult to accurately predict the performance of storage technologies. Without accurate projections, some grid operators may choose proven energy sources and technologies (such as natural gas, coal, and nuclear) instead. As new energy storage technologies are developed, they will create new information needs to support planning efforts.

- **Optimizing performance models.** Without accurate, timely data on how storage could contribute to a utility's resource portfolio, storage adoption may be delayed. Experts told us that grid operators may lack the ability and tools to model estimated storage capacity needs and the effects of such technology's use on the electricity grid. Modeling supports utilities' analyses of future energy resource portfolios to meet customers' energy needs through a process called



resource planning.<sup>75</sup> Literature we reviewed consistently showed that storage can play a key role in short-term peak shaving, but agency officials told us that developing precise models that forecast storage's full performance potential remains a challenge.

- **Predicting storage's role in electricity resource plans.** Planning efforts vary across regional, state, and local authorities, and literature we reviewed showed us that energy storage planning efforts are disjointed. This variation, according to a National Academies report, was driven by policymakers' choices to place a greater emphasis on decentralized markets and competition.<sup>76</sup> Multiple independent parties operating and modernizing the grid differently have created divergent interests among planners and authorities. Experts told us that a roadmap could be used to organize and guide development efforts. DOE released a roadmap to accelerate the development, commercialization, and utilization of next-generation energy storage technologies and to sustain

American global leadership in energy storage in December 2020.<sup>77</sup> However, according to agency officials we interviewed in 2022, federal engagement efforts can be limited by a lack of states' efforts in energy storage development and planning. It remains unclear if federal leadership could effectively coordinate efforts to realize energy storage's potential across the U.S.

- **Growing backlog of interconnection requests.** New storage projects can be subject to a cumbersome, outdated interconnection process. As a result, large numbers of proposed variable renewable energy and energy storage projects are not transitioning into commercial operations. Before a generating facility, such as a new battery storage facility, can supply electricity, a project developer must request to interconnect to the electricity grid.<sup>78</sup> As a part of this process, interconnection studies are performed by transmission providers—such as an RTO or ISO—to assess the system impacts of new facilities. See figure 10 for a diagram of the interconnection study process.

---

<sup>75</sup>Most states require utilities to engage in resource planning to substantiate that the utility's plans meet demand for electricity services. Planning varies greatly by state, but is typically accomplished through processes set by the state utility regulator. Resource planning is becoming increasingly complex, requiring analysis of state policies on electrification and clean energy as well as the interplay of variable generation and the time and location valuation of demand-side resources such as energy efficiency, demand response, and energy storage.

<sup>76</sup>National Academies, *The Future of Electric Power in the United States*.

<sup>77</sup>Department of Energy, *Energy Storage Grand Challenge Roadmap*, (December 2020).

<sup>78</sup>Interconnection is an approval process by which new energy systems, including storage, can be legally connected to the electricity grid. The grid must be able to receive the power from the new generating facility and send it along paths on the grid that ultimately reach consumers. As such, the interconnection process focuses on how to effectively integrate new generating projects to the existing grid, which requires studying the reliability impacts of the proposed generating facility's interconnection and determining the costs of any new or upgraded transmission facilities needed to mitigate those impacts.

**Figure 10: Simplified interconnection study process**

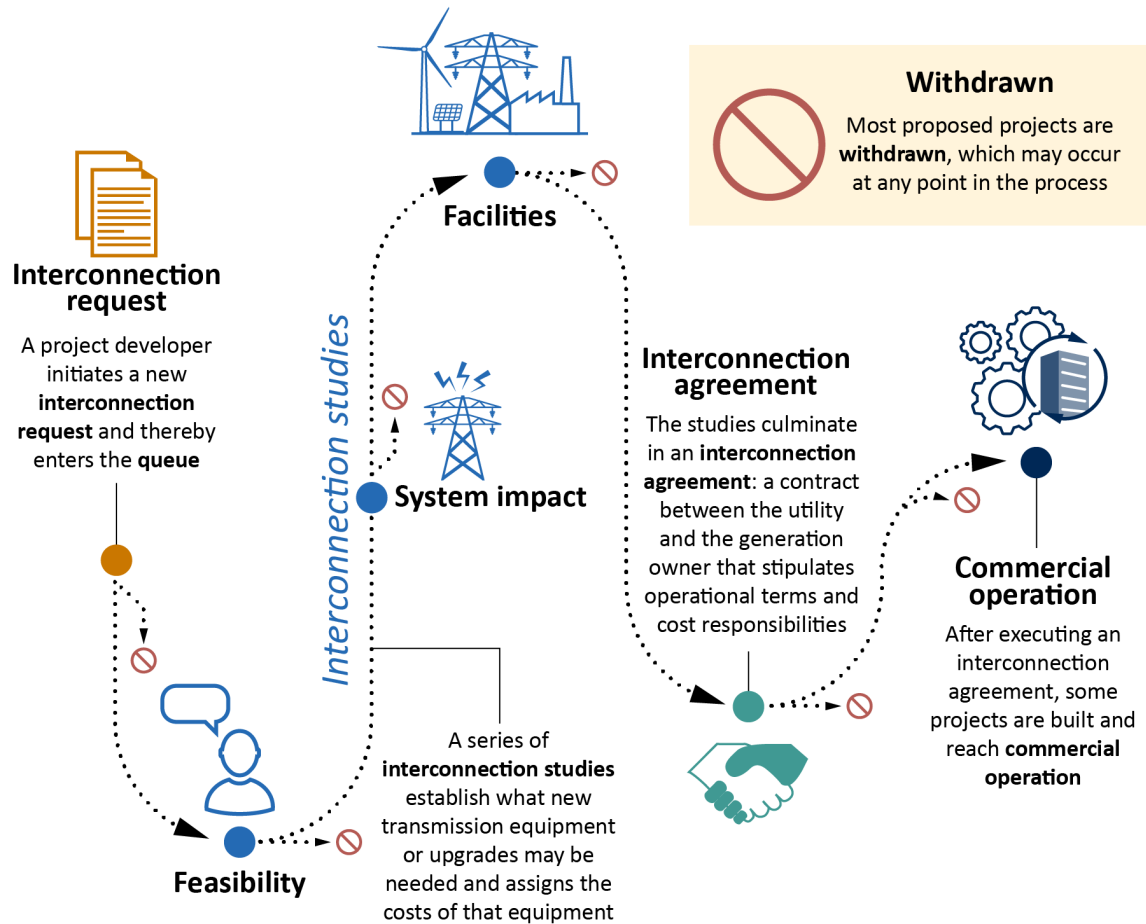

Source: Derived from image courtesy of Lawrence Berkeley National Laboratory and used with permission. | GAO-23-105583

The typical duration from interconnection request to commercial operations for any new project was over 2 years in the period from 2000-2010 and increased to nearly 4 years for projects in 2010-2021, according to a national laboratory study.<sup>79</sup> These delays are because of substantial increases in

interconnection requests and incomplete, untimely interconnection studies. Officials said, interconnection costs are also increasing over time and may be higher for energy storage than for technologies like solar, gas, or wind energy. In addition, experts told us that unreasonable fees and arbitrary

<sup>79</sup>Joseph Rand et al., *Queued Up: Characteristics of Power Plants Seeking Transmission Interconnection As of the End of 2021*. Lawrence Berkeley National Laboratory (Berkeley, CA: April 2022). This study analyzed renewable energy and energy storage projects. Approximately 98 percent of the storage projects were battery projects, but also included pumped hydroelectric storage, compressed air energy storage, and other technologies.

requirements contribute to delays. FERC—the federal agency responsible for issuing interconnection rules—has proposed interconnection reforms to address backlogs by issuing a notice of proposed rulemaking.<sup>80</sup> Specifically, FERC proposed to revise its interconnection rules to, among other things, implement a procedure by which interconnection requests are processed based on when customers meet certain development milestones; implement a mechanism to study interconnection requests in groups; increase the speed of interconnection queue processing; and incorporate technological advancements into the interconnection process. As of October 2022, FERC is receiving comments on the proposed reforms.

### 3.2 Challenging regulatory environment

The regulatory environment—which includes market rules and regulations, variation across regions and states, and permitting processes—can pose challenges to energy storage deployment. For example:

- **Market rules and regulations.** Uncertainty resulting from pending and potential market rules and regulations may delay storage adoption. Market rules and regulations in some regions and states are characterized by unique and different regulatory guidelines between transmission and generation, which may discourage investment in utility-scale storage projects. For example, some regions and states do not allow utilities

that directly serve customers to own energy storage technologies. Similarly, some regions or states may only characterize energy storage facilities as either a generation or transmission asset. This undercuts one of the key features of storage systems—their ability to earn revenue from multiple services, such as relieving grid congestion and avoiding the construction of new infrastructure.

- **Variation across regions and states.** Rules and regulations vary across regions and states, which introduces additional challenges for energy storage deployment and use. This variation forces energy storage project developers to navigate a patchwork of potential markets. For example, developers must be knowledgeable about multiple regulatory agencies to predict potential revenue streams—various sources of generated income. Similarly, developers that want to deploy storage across multiple markets may need to conduct separate analyses to determine each region’s regulatory outlook, requirements, and profit potential.
- **Permitting.** New storage project permitting and other approval processes can require significant investment and be lengthy. Without an update to these processes, new storage facilities can experience delays in coming online, which may prevent them from contributing to time-specific energy goals. Such processes help to ensure that environmental and stakeholder concerns are addressed before system operation. However, energy storage projects with long lead

---

<sup>80</sup>Improvements to Generator Interconnection Procedures and Agreements, 87 Fed. Reg. 39934 (July 5, 2022).

times and high up-front costs, could take years to realize any potential benefit. For example, stakeholders told us constructing new pumped hydroelectric storage facilities can take more than a decade because of permitting and interconnection requirements. California legislation passed in June 2022 aims to expedite and streamline aspects of the review and authorization process.<sup>81</sup>

Federal reform efforts were proposed as part of an amendment to the James M. Inhofe National Defense Authorization Act for fiscal year 2023, but the amendment was ultimately withdrawn.<sup>82</sup>

### 3.3 Existing codes and standards do not fully address energy storage technologies

Existing codes and standards may need to be revised and new standards may be needed. Codes and standards protect human life and ensure the reliability and safety of systems. They do so by providing guidance on the design, use, or performance of processes, systems, and services. According to literature we reviewed, in order to promote innovation among all energy storage technologies, standards should be open—fully accessible for free to the public—and technology-neutral. Such standards should enable effective communication among the systems and people that manage the grid and its resources.

Storage system evolution and deployment is outpacing codes and standards development. A stakeholder we spoke with said that

standards may require continuous evolution to keep pace with storage developments. As we reported in May 2018, standards development tends to lag behind that of storage technologies, and experts told us that this remains a concern as of September 2022.<sup>83</sup> In addition, standards related to storage—such as UL 9540, a standard for safety of energy storage systems and equipment—may not be freely available to the public. As a result, entities seeking to deploy new technologies may face challenges applying existing codes and standards to them. For example, new energy storage systems will require new forms of testing to ensure they perform as expected under various conditions, but the testing will not yet be part of existing standards. This situation leaves developers unable to evaluate a storage system’s safety prior to deployment, thus passing the safety risks to operators and the public.

Battery fires could affect future battery energy storage deployment decisions in urban areas or in proximity to other grid resources. For example, a battery fire at a California-based energy storage facility shut down a major highway in September 2022. Battery facilities are susceptible to thermal runaway events, which may cause fires. These events are expected to continue, according to stakeholders we interviewed. Moreover, local jurisdictions and emergency responders, along with storage system installers and insurers, may not have a complete understanding of these hazards or how to mitigate them. According to stakeholders we interviewed, energy storage facility fire safety

---

<sup>81</sup>2022 Cal. Stat. Ch. 61 (A.B. 205).

<sup>82</sup>S. Amdt. 6513, 117th Cong. (2022).

<sup>83</sup>GAO-18-402.

training is not commonly available and fire suppression systems may be inadequate. For example, firefighters were injured in an Arizona-based lithium-ion battery energy storage system explosion in April 2019. Inadequate detection and suppression systems were highlighted as contributing factors. Fire hazards and other operational safety concerns will remain for deployed storage systems unless codes and standards keep pace with rapid development.

### 3.4 Crosscutting challenges

The rapid evolution of energy storage technologies has made it difficult for stakeholders to determine their costs, benefits, and impacts on the U.S. electricity grid. Through our analysis of literature and stakeholder views, we identified five crosscutting challenges that constrain efforts in advancing energy storage technologies:

- **Lack of experience among stakeholders.** Beyond pumped hydroelectric storage, some operators may not have experience planning for energy storage technology operation and use on the grid and, thus lack the impetus to invest in them. Stakeholders said that grid operators and utilities lack familiarity with emerging energy storage technologies and the impacts of integrating them onto existing grid systems. Furthermore, understanding how these resources can be incorporated into a utility’s electricity resource planning process presents an additional

layer of complexity to navigate, according to stakeholders. We reported in September 2018 about multiple considerations for maintaining U.S. competitiveness through transformational technological advances.<sup>84</sup> According to experts, one of these considerations was focusing on technology development and commercialization by providing support across multiple stages of the technologies’ innovation. However, as of December 2022 energy storage development and use has largely focused on the advancement of battery technologies. Policymakers may be required to explore and diversify investments to prevent technology “lock-in,” which occurs when adoption of one dominant technology drives out alternatives. In addition, the workforce needs to be trained to manufacture, install, maintain, decommission, and recycle storage systems.

- **Risk aversion.** Some stakeholders we interviewed told us that companies and grid operators are not always willing to take risks on new technologies, preferring instead to invest in and bring to the grid established, proven technologies. What is considered an established technology varies across the country, however. For example, large-scale battery storage capacity is rapidly growing across the U.S., but one stakeholder we interviewed does not consider batteries to be an established technology and uses them in

---

<sup>84</sup>GAO. *Science and Technology: Considerations for Maintaining U.S. Competitiveness in Quantum Computing, Synthetic Biology, and Other Potentially Transformational Research Areas*, GAO-18-656 (Washington, D.C.: Sept. 26, 2018).

a limited capacity. As grid operators and utilities continue to consider how to integrate these technologies into the grid, they should identify risks and define risk tolerances, according to experts.

However, experts said that adoption of storage systems may be limited unless risk tolerances related to reliability are adjusted. Additionally, grid operators are subject to reliability standards and some non-compliance fines can exceed \$1 million per day per violation.

- **Limited availability of critical minerals.** We reported in June 2022 that the U.S. is import-reliant on critical minerals used to manufacture energy storage systems, such as batteries.<sup>85</sup> These minerals are critically important to U.S. economic prosperity, national security, and future energy goals. Battery technologies will compete with other advanced technologies for access to these minerals as their use is not limited to energy storage systems. Global and domestic supply chains must account for these competing demands. The U.S. lacks domestic critical minerals production, but has the potential to offset its dependence on foreign suppliers by advancing critical mineral recovery and substitution. For example, critical minerals can be extracted from systems that have reached the end of a system’s usable life. However, as of March 2021 there are only policies in two states—California and

North Carolina—addressing recovery or recycling of lithium-ion batteries, according to a National Renewable Energy Laboratory report.<sup>86</sup>

- **Limited domestic manufacturing capacity.** Although lithium-ion battery production has grown worldwide in recent years, the U.S. does not have the domestic infrastructure and personnel needed to support manufacturing of utility-scale energy storage systems. According to literature we reviewed, the U.S. is becoming increasingly reliant on foreign suppliers and on the technologies they are developing. That reliance, according to a National Academies report, is unlikely to change.<sup>87</sup> Furthermore, multiple storage technologies may work together to provide energy and many different storage durations may be required to satisfy grid needs. Because of this, the U.S. has an opportunity to grow additional manufacturing bases for storage systems that have not reached technology maturity.
- **Cybersecurity concerns.** According to some experts, energy storage systems are susceptible to cybersecurity risks common to the electricity grid.<sup>88</sup> Another expert told us that unique threats also exist. For example, battery management systems may be attacked to cause malfunctions that result in local to system-wide failures. Further, we

---

<sup>85</sup>GAO-22-104824.

<sup>86</sup>National Renewable Energy Laboratory, *A Circular Economy for Lithium-Ion Batteries Used in Mobile and Stationary Energy Storage: Drivers, Barriers, Enablers, and U.S. Policy Considerations* (2021).

<sup>87</sup>National Academies, *The Future of Electric Power in the United States* (2021).

<sup>88</sup>The expert meeting was not designed to produce a consensus among the experts. We use phrasing such as “according to experts” to denote comments made by multiple experts without disagreement. We use phrasing such as “according to some experts” in cases where multiple experts made similar comments, but other experts disagreed.

reported in March 2021 that the U.S. electricity grid distribution systems are increasingly at risk from cyberattacks, including attacks that compromise networked consumer devices.<sup>89</sup> One expert also said that cybersecurity standards are up-to-date, as of October 2022, but policymakers may lack processes to support and enforce compliance of cybersecurity activities with applicable requirements.

### 3.5 Valuing energy storage

Realizing the potential of energy storage technologies may depend on how systems are charged, the ability to value investments, and on the availability of longer-duration storage.

- **Charging.** Increasing energy storage capacity could allow for increased use of variable renewable electricity generation technologies. Potential benefits include the reduction of greenhouse gases and other emissions because of reductions in fossil fuel plants. For example, peaker plants emit hazardous pollutants like sulfur dioxide and nitrogen oxides that may increase risks for cancer, heart disease, and other adverse health conditions. In addition, storage can increase electricity grid flexibility and decrease renewable curtailments. However, lithium-ion batteries are often integrated into solar power facilities in a

way that can limit the ability for batteries to charge from the grid. This limits the applications the batteries can perform, but was previously necessary to be applicable for the investment tax credit.<sup>90</sup> Although energy storage technologies could help to reduce emissions, one expert told us that energy storage systems may also charge from nonrenewable resources and the near-term use of these systems may increase greenhouse gases and other emissions.

- **Valuing investments.** Valuing investments and assessing storage's potential benefits and costs can prove challenging.<sup>91</sup> Benefits can be difficult to quantify, as they depend on a technology's application, location, and ability to capture multiple benefits. Specifically, as we previously discussed, profit potential for services that storage can provide reflects local market rules and regulations which can vary across regions and states. Stakeholders and experts said that reliable estimates of a storage asset's expected life can vary and are necessary for accurately estimating its life cycle costs and benefits. Sufficient information on storage system cost may not be readily available, and can limit utilities' ability to include storage in modeling and investment decisions.
- **Longer-duration storage.** According to stakeholders, while shorter duration storage is being installed to support

<sup>89</sup>GAO. *Electricity Grid Cybersecurity: DOE Needs to Ensure Its Plans Fully Address Risks to Distribution Systems*, GAO-21-81 (Washington, D.C.: Mar. 18, 2021).

<sup>90</sup>The investment tax credit was expanded by the Inflation Reduction Act of 2022 to include standalone energy storage technology with a minimum capacity of five kilowatt-hour. Pub. L. No. 117-169, § 13102, 136 Stat. 1818, 1913-22.

<sup>91</sup>One expert noted, investment valuation may also include societal values such as a reduction in air pollution or increased electricity system reliability.

variable renewable energy generation, longer-duration energy storage—storage that can discharge for 10 or more hours at its rated capacity—is needed as more renewables are deployed on the grid. However, as we discussed in chapter 2, the actual duration needed for energy storage can vary significantly from seconds to as long as multi-day or seasonal storage. This variance increases

the challenge of communicating longer-duration storage’s potential role and opportunities to grid operators, especially when considering the economics of different, emerging technologies that may provide different services. Regulatory and market frameworks will likely need to consider this variation in order to appropriately value longer-duration storage.



## 4 Policy Options to Address Energy Storage Technology Challenges

We developed policy options that policymakers—Congress, federal agencies, state and local governments, academic and research institutions, and industry—could consider taking in response to the challenges identified in chapter 3 and a status quo policy option. This is not an exhaustive list of policy options. We intend for these options to further assist policymakers in addressing the effects of utility-scale energy storage technologies. The status quo policy option, described below, illustrates a situation if policymakers take no additional action beyond any current efforts.

### 4.1 Status quo

*Policymakers have supported new ideas, methods, and tools that could be used to develop and deploy storage technologies.*

#### Actions Taken

- The federal government has driven the technical development of energy storage technologies and incentivized developers through financial support of early demonstration projects, improving market rules, and a series of grant programs.
- Regulators have removed some barriers to energy storage market participation and some states have taken actions to deploy energy storage.
- DOE has facilitated the research and development of energy storage technologies, with a focus spanning laboratory research to early commercial development.
- Many states have taken legislative and regulatory actions relating to the future of the electricity grid, such as studies and investigations, planning and market access, grid modernization policies, and financial incentives for energy storage.

#### Opportunities

Storage technologies have tremendous opportunities to support future grid operations and policymakers at federal and state levels have begun to implement diverse policies. Specifically, the federal government has various national capabilities to support policymaker decisions around energy storage:

- **Energy Storage Grand Challenge.** DOE established this program in December 2020 to develop and commercialize next-generation energy storage technologies. As a part of this program, the National Renewable Energy Laboratory published the Storage Futures Study to explore how energy storage could impact the evolution and operation of the U.S. power sector.<sup>92</sup>
- **Energy Earthshots Initiative.** DOE launched the Long-Duration Storage Shot

---

<sup>92</sup>Blair, Nate, Chad Augustine, Wesley Cole, et al., *Storage Futures Study: Key Learnings for the Coming Decades*. (Golden, Co.: National Renewable Energy Laboratory, 2022).

in September 2021, which established a target to reduce utility-scale energy storage costs by 90 percent for systems that deliver 10 hours or greater storage duration within the decade.

- **Infrastructure Investment and Jobs Act.** In October 2022, DOE announced a \$2.8 billion funding opportunity to support battery materials processing and manufacturing funded by the legislation.<sup>93</sup>
- **Inflation Reduction Act of 2022.** This legislation contains various provisions related to energy storage. For example, it created new and expanded existing tax credits for commercial investment and development of standalone energy storage systems.<sup>94</sup>

Some states have also begun to develop different pathways for greater energy storage through public utility commissions, legislatures, and executive directives from governors. Pathways include:

- **Enabling** storage to access the grid and markets by lowering barriers to entry,
- **Including** storage in the resource planning process, and
- **Valuing** energy storage benefits.

These state actions may vary depending on whether the energy market is structured into a traditionally regulated or deregulated market. State goals and targets can incentivize investor-owned utilities to

integrate storage in their planning efforts. States may continue to assess energy storage in action or climate plans and create programs to incentivize storage development and deployment.

### Considerations

Without greater information on rapidly evolving storage capabilities, policymakers may lack sufficient information to make decisions. For example, uncertainties exist about the cost, performance, valuation, and integration of hybrid utility-scale energy storage despite its increase in popularity over the previous 3 years. Policymakers could lack information on what storage can do, how to effectively plan storage on the grid, and how storage can be fairly valued. Decreased system resilience, inefficient investments, and suboptimal grid operation could occur without this information. Last, the mixed U.S. electricity system of regulated and deregulated environments is highly diverse and this makes it difficult to engage in long-range planning across the country.

Storage development, deployment, and use could be left dependent on forces outside policymakers' control without additional storage-specific policies. For example, there is a vulnerable supply chain of lithium battery materials and laboratory officials told us geopolitics plays a significant role in battery reuse. The U.S. depends on other countries, primarily China, for most battery materials, subcomponents, and batteries themselves.<sup>95</sup> There is also a lack of developed supply chains

---

<sup>93</sup>Pub. L. No. 117-58, Div. J., Tit. III, 135 Stat. 429, 1368 (2021).

<sup>94</sup>Pub. L. No. 117-169, §§ 13102, 13501-02, 136 Stat. 1818, 1913-22, 1969-81.

<sup>95</sup>DOE, *Grid Energy Storage: Supply Chain Deep Dive Assessment*, (February 2022).

for nascent technologies, such as flow batteries or compressed air energy storage, because of their minimal adoption.

## 4.2 Integrating storage technologies

*Policymakers could include clear goals and next steps, based on an assessment of storage costs and benefits, in plans to integrate storage on the grid.*

### Implementation Approaches

- States' energy offices could establish a roadmap, based on studies of storage costs and benefits, which describes goals for energy storage and actions to reach them.
- Public utility commissions could evaluate energy storage alongside traditional resources in their review of utilities' plans, or encourage utilities to evaluate storage, as appropriate.

### Opportunities

This option could encourage adoption of energy storage by better incorporating it into planning processes, in particular for states unfamiliar with storage technologies. For example, roadmaps or action plans could help policymakers understand storage technologies or recommend to stakeholders within states the policies needed to support storage deployment. New York developed an energy storage roadmap in 2018 that identified deployment opportunities, use cases, and actions the state could undertake to support various energy storage applications. Roadmaps may also help states reach consensus on, and eliminate, the most

disruptive barriers to energy storage deployment. Minnesota lawmakers passed legislation in May 2019 directing the Minnesota Department of Commerce to conduct an analysis of the potential costs and benefits of deploying energy storage in the state. See figure 11 for other examples of energy storage efforts taken by states.

Clearer, more concrete goals and next steps in long-term planning could also increase investor confidence and reduce the uncertainty developers may face while considering new pumped hydroelectric storage projects. For example, new pumped hydroelectric storage facilities are susceptible to future market uncertainty and could benefit from additional planning activities to encourage their development and deployment, agency officials told us.

System planners could prepare and adequately plan for a significant increase in deployed battery energy storage across the U.S. grid. Policymakers, regulators, and other oversight bodies could oversee plans that encourage storage innovation and deployment. Innovations and deployment actions may include (1) retrofitting existing energy storage facilities; (2) co-locating energy storage systems with existing power plants that are being retired; (3) identifying and disseminating interconnection best practices; and (4) providing technical assistance to help streamline storage interconnection processes. Plans with goals to modify existing policies could also help states with activities needed to integrate and optimize battery and other storage technology deployment on the grid through grid modernization and resource plans.

**Figure 11: Examples of state energy-storage efforts**

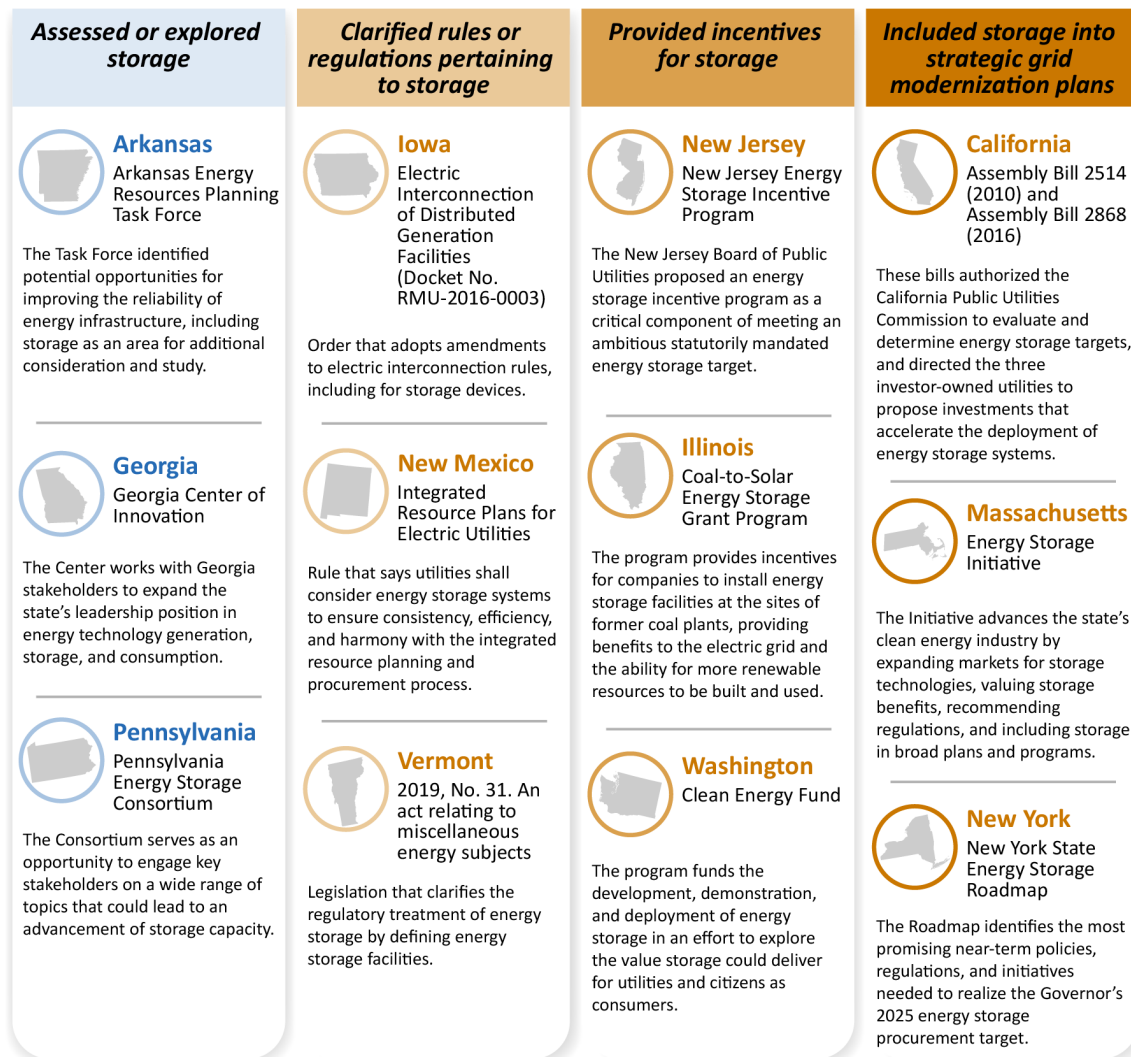

Source: GAO analysis. | GAO-23-105583

**Considerations**

Plans that seek to alter conventional grid planning could be difficult to execute. Energy storage is uniquely capable of providing a wide range of services to the electricity grid, but conventional planning has separate processes for generation, transmission, and distribution, according to stakeholders. Most utilities and system operators have little experience with including utility-scale storage

in planning, according to the Massachusetts Institute of Technology. One stakeholder we interviewed said they have narrow planning processes that do not allow utilities to consider a variety of storage technologies, and another stakeholder suggested project solicitations should be inclusive of various technologies to meet storage needs. Other stakeholders told us they are beginning to analyze the impact battery systems may have on their grid as of July 2022, or they had little

experience operating utility-scale storage, which includes integrating energy storage.

Successful storage planning depends on many factors. Regions may need different amounts of storage because each state regulates energy storage differently. Renewable energy generation varies geographically—not every technology is suited for every location. Additionally, long-term storage investment planning is complicated by imperfect information about future costs, resource availability, wholesale market prices, and assumptions about future electricity demand.

Variability in these long-term planning factors is likely to increase with changing climates, which could impact grid planning, according to stakeholders. Some state governments have also set different goals for lowering carbon emissions, while others have no such goals. On the consumer side, some large companies have made commitments to purchase certain amounts of electric power from low-carbon generation sources. Such measures have helped result in an increase of green power sources such as wind and solar electricity generation in the U.S.

### 4.3 Revising and enacting rules and requirements

*Policymakers could revise and enact rules and requirements that govern how storage is used, owned, or defined.*

#### Implementation Approaches

- State regulators could assess and modernize energy storage definitions, along with storage ownership models.

- State agencies in regulated markets could identify barriers to energy storage market participation and define regulator responsibilities.
- States could establish energy storage deployment mandates, targets, or goals based on a cost and benefits assessment of these efforts. States could investigate activities needed to understand how future targets or requirements might be set.
- Regulators could streamline permitting and identify existing interconnection requirements that might be revised to better suit the incorporation of energy storage onto the grid.
- State and local policymakers could provide guidance on how storage technologies fit into existing zoning, permitting, building codes, and other jurisdictional areas.

#### Opportunities

The regulatory environment presents challenges to the use of energy storage (see 3.2), and reforming and aligning rules could help overcome these. For example, allowing energy storage to be used for multiple grid applications (e.g., generation, transmission, and distribution) could promote these technologies by improving grid efficiency while reducing costs for all customers.

Some states have assessed ownership models already. For example, Oregon enacted legislation in 2015 directing electric companies to submit proposals to its Public Utility Commission to procure energy storage systems with the capacity to store at least 5 megawatt-hours of energy by 2020. In 2022, the Minnesota Public Utilities Commission

approved Xcel Energy’s plan to retire all of the company’s coal-powered generators and explore options for adding new technologies such as energy storage. The grid and customer benefits could be maximized by enhanced energy diversity and optimal cost-effective system performance when electric companies own and operate energy storage.

Providing guidance to storage developers about permitting fees, siting, and other requirements can help lower costs and reduce the timeline for interconnection. Permitting best practices and resources are growing and policymakers could adopt these examples, such as New York’s model permit and checklist system for energy storage. Checklist information could help accelerate permit approval timelines and save time by reducing the number of incomplete permit applications.

### Considerations

The U.S. grid was built before energy storage technologies were widely available and no single planner is responsible for the U.S. power system. These differences could blur the lines between federal and state authority and lead to confusion over setting and enforcing rules, or become a major potential barrier to storage deployment. One expert said there is no single entity in charge to coordinate regulations and ensure regulations do not adversely affect the grid.

Each state has unique and different regulatory guidelines, which could make

finding the right model to achieve energy goals a challenge. Markets in some states are regulated by public utility commissions, where utilities own or control generation, transmission, and distribution. RTOs and ISOs oversee the generation and delivery of electricity to consumers in some markets. Siting and permitting authority also varies, as some states hold siting authority for certain electric facilities and others delegate authority to local governments.<sup>96</sup> Developing regulations to allow storage to be used for dual-use (as a regulated transmission service and competitive market service) is also complicated. As a result, no regional market has yet implemented the changes necessary to allow for dual-use energy storage as of February 2022.

Changes to rules and regulations could exclude certain types of energy storage technologies. For example, the PJM market previously had a rule that determined a storage resource’s market capability by calculating the power it could provide over 10 continuous hours. However, this excluded lithium-ion batteries, which typically provide durations of approximately 2 to 4 hours. Technology-neutral rules and regulations could reduce the possibility that innovation barriers arise and become a significant risk for battery storage development, according to both an expert and to stakeholders we interviewed.<sup>97</sup> Similarly, another expert suggested ancillary and reliability services should be technology-neutral so that rules are

---

<sup>96</sup>J. Kahn and L. Shields, *State Approaches to Wind Facility Siting*, National Conference of State Legislatures, Sept. 2, 2020.

<sup>97</sup>Technology-neutral policies are performance- or outcome-oriented without regard to a specific technology, according to the National Academies of Sciences, Engineering, and Medicine.

geared toward services needed rather than specific storage types.

#### 4.4 Updating or creating codes and standards

*Policymakers could update or create new codes and standards, and educate people on utility-scale energy storage safety risks.*

##### Implementation Approaches

- Regulators could support open or technology-neutral standards, such as those related to safety and operation.
- Governments could train local first responders and developers could educate local communities about safety through stakeholder consultation, while leveraging DOE support for workforce development.
- Developers, operators, and users should follow established industry best practices and guidelines on storage safety and participate in DOE-led trainings.

##### Opportunities

Codes and standards that are fully adopted alongside maturing energy storage technologies can help minimize incidents that compromise public safety and welfare. Energy storage systems are rapidly evolving and the development of new energy storage technologies is increasing. Codes and standards, such as UL 9540 and National Fire Protection Association 855, exist to ensure storage technologies protect public health, safety, and welfare.

Laboratory officials said guidelines or best practices could help address energy storage

safety, and additional safety design and development research is needed to address storage risks. Recent developments in battery testing, research, and commercially available systems could be incorporated into updated codes and standards.

One expert told us regulators could choose the best standards or a combination of different standards and place them into regulations to help address safety and performance requirements. Enforcing fire codes and other standards could also help stakeholders become more aware of storage standards. As storage technologies mature, codes and standards could be adopted more quickly through proactive engagement between utilities, storage facility owners or operators, and standard-setting organizations.

Education and workforce training programs could help people operate energy storage systems more safely. These programs could train people to apply codes and standards by teaching qualifications and skills to build greater knowledge on how storage systems function, ensuring energy storage systems are connected safely:

- **Training programs.** The Virginia Energy Storage Task Force recommended a training program that educates firefighters, electric line workers, and other emergency personnel about (1) how to appropriately respond to fires at energy storage devices and (2) the differences in battery technologies to help ensure battery devices are safely deployed.
- **Guidebooks.** Other stakeholders said developing an easy-to-understand technical guidebook could help small

utilities better understand how storage systems work.

- **Community outreach.** One stakeholder told us they conduct outreach with local communities near potential energy storage development sites to help familiarize people with battery systems.
- **DOE expertise.** Program staff at Pacific Northwest National Laboratory and Sandia National Laboratories hold safety training for state policymakers and disseminate best safety practices through the Energy Storage Safety Collaborative.
- **Internet guidance.** Local governments could also post storage inspection and site-safety requirements on easy-to-find websites. The city of Palo Alto, California, posted a permitting and inspection process document for energy storage systems.

### Considerations

Codes and standards take time to develop, with one expert noting the process can take several years, and policymakers could be following outdated ones if they are not adopted in a timely manner. According to DOE, it could take on average 2 years for states and local governments to adopt new codes or standards after they are published.<sup>98</sup> In worst case scenarios, there could be delays of up to 5 years or longer from the time the code development process starts until the code is adopted. Additionally, codes and standards include fire detection, and laboratory officials said states adopt their

own fire codes. Laboratory officials told us some states have fallen behind on using new fire codes because adoption has fallen behind the rapid pace of energy storage technology development.

Ambiguous safety standards could make it more difficult to properly design storage systems, according to laboratory officials. One expert said it may be complicated for stakeholders to understand which standards they need to follow or if they should follow any standards. Regulator authority also depends on the storage technology and where the system is installed. There may be more than one authority with jurisdiction to verify compliance with codes or standards.

Energy storage systems could be removed from the market or cause entities to be more conservative when administering safety requirements if public welfare is adversely affected following a safety incident. Major failures, fires, and explosions associated with storage also result in public backlash. Storage technologies present a variety of safety concerns:

- **Battery systems** contain large amounts of energy and may contain hazardous materials or moving parts. Lithium-ion batteries, in particular, are susceptible to fires or explosions generated during a thermal runaway event.
- **High-powered flywheels** are susceptible to structural failure bursts, which could lead to explosions.

---

<sup>98</sup>Pacific Northwest National Laboratory and Sandia National Laboratories, *Energy Storage System Guide for Compliance with Safety Codes and Standards* (June 2016).



- **Pumped hydroelectric storage** reservoirs could be closed to recreation because of safety concerns. Artificial reservoirs can overflow or are subject to failure, which could endanger residents and workers downstream of the reservoir.

These differing energy storage technologies make it more difficult for policymakers to develop a single set of protocols that could evaluate and improve their safety. Safety risks increase as either the level of storage technology maturity decreases or the level of deployment increases. Additionally, some people may not follow standards and codes in storage development and deployment, which could risk affecting public safety. It could be difficult to determine what storage system is safe without criteria that are developed, adopted, and followed within codes and standards.

#### 4.5 Addressing crosscutting challenges

*Policymakers could support actions to help overcome energy storage manufacturing and adoption barriers.*

##### Implementation Approaches

- Federal and state governments could enact clear and consistent policies for utility-scale battery reuse and end-of-life recycling to help with domestic manufacturing and critical minerals availability.
- Developers and state or local governments could conduct more stakeholder outreach and expand energy storage education programs to help

increase community awareness and adoption of energy storage technologies.

- The federal government could target research and funding to support longer-duration energy storage development, demonstration, and deployment.

##### Opportunities

New utility-scale battery reuse and recycling policies could help enable a system that allows for long life, high performance, and the recovery of products and materials. For example, policies that fund analysis of battery market opportunities could help alleviate market uncertainty and lead to more cost-effective technologies. Further, policies that incentivize reuse and recycling could help make early market investment economics more desirable for new secondary use applications.

Public outreach could help stakeholders overcome awareness and familiarity challenges by educating communities about energy storage technologies, stakeholders told us. Outreach accomplished through advisory groups, temporary working groups or task forces, and public input periods could also help regulators and state legislatures give communities a voice in the making of public policies and develop legislation that represents the people most affected. Increased educational and outreach programs that connect the benefits and impacts of energy to consumers' everyday lives could help build political and public will for policy changes. Greater information on the role storage plays in the energy system can help mayors, city councils, and state offices consider storage policies that promote grid reliability and resilience within their jurisdictions.

Targeted federal financial support for longer-duration energy storage development and demonstration should be considered since longer-duration storage may be important in a future electricity system powered by wind and solar generation. The key services storage offers in a high-renewables world are energy and reliability. Longer-duration storage technologies, such as flow batteries and metal-air batteries, when optimally deployed could increase the value of renewable energy generation and produce moderate electricity cost reductions.

### Considerations

There are few policies for battery reuse, recycling, and end-of-life as of March 2021. National Renewable Energy Laboratory researchers found there are only two states that have policies that address battery reuse or end-of-life management for stationary and mobile battery systems.<sup>99</sup> Industry may have limited incentives or motivation to invest in new battery recycling applications. This is because of minimal information on the value of reused and recovered batteries that could inform new industry investments.

Manufacturing large-scale energy storage technologies could be complicated. Agency officials said companies may struggle with storage system engineering. Specifically, it is difficult to develop a new storage technology, build a prototype, and commercialize it. This process could take 10 years or longer to complete for longer-duration storage technologies because of their larger scales

and extended timelines. Additionally, new pumped hydroelectric storage projects are unlikely to be competitive against natural gas electricity generation because low-cost, flexible natural gas generation has reduced electricity prices, according to a Massachusetts Institute of Technology report.<sup>100</sup>

Other energy storage technology innovations may not gain similar cost-reduction benefits to help adoption as those that lithium-ion battery technology received, according to agency officials. This is because lithium-ion batteries have a large manufacturing base that has been supported by consumer cell phones, computers, and electric vehicles for approximately 2 decades.<sup>101</sup> Lithium-ion battery market concentration has made it difficult for producers of alternative storage technologies to survive, innovate, and scale up.

Financial factors could influence energy storage innovation and adoption:

- **Short-term subsidies.** Some federal and state subsidies may favor near-term storage projects which could encourage rushed projects that may be less effective at achieving climate mitigation goals beyond 2030. Such funding may be spent on previously planned storage projects or

---

<sup>99</sup>National Renewable Energy Laboratory, *A Circular Economy for Lithium-Ion Batteries*.

<sup>100</sup>Massachusetts Institute of Technology, *The Future of Energy Storage*.

<sup>101</sup>The lithium-ion battery was first introduced to the commercial market in 1991. It has been used throughout the electric device industry, including in cell phones, and electric vehicles.

technologies that may never reach commercialization.<sup>102</sup>

- **Unpredictable funding.** Federal funding can fluctuate from year to year, according to national laboratory officials. This makes it difficult for these laboratories to plan long-term storage studies, attract and maintain talent, or develop new storage technologies.
- **Sharing costs.** DOE cost-sharing model allocations between the government and industry could deter companies from applying for funding announcements where the burden of cost is high for industry.

#### 4.6 Incentivizing energy storage

*Policymakers could create mechanisms to incentivize storage deployment and monetize storage revenue streams.*

##### Implementation Approaches

- Governments could provide tax credits, rebates, or grants and encourage creative financing methods for energy storage deployment, particularly for longer-duration energy storage.
- DOE and FERC could improve software tools for energy storage by coordinating the private industry and academic researchers needed to collaborate in developing new tools, such as through technical conferences.

---

<sup>102</sup>There can be a gap in funding and investment support that makes it challenging to translate research into commercialized products or services because of innovation risk and long time frames associated with technology development.

- States with traditionally regulated utilities could consider policies that encourage owners or operators to capture multiple revenue streams from energy storage.

##### Opportunities

Targeted government incentives support can have an important and positive impact on the energy storage market as it transitions through a period of growth similar to the wind and solar markets. For example, laboratory officials said tax credits may accelerate energy storage deployment if no market demand exists for storage technologies and help mitigate market uncertainties businesses face. Incentives, such as loan guarantees, loan forgiveness, or tax credits, could also help companies develop longer-duration energy storage technologies, stakeholders told us. Incentives could also stimulate a market for storage while regulatory rules and policies are finalized that could allow for energy storage to participate.

Valuing storage with new open-access modeling, simulation, and analysis tools in an evolving grid with states or regions that have varying market rules could help policymakers understand the potential value and opportunities storage provides.<sup>103</sup> These tools could help provide a basis for objective discussion and more rapid decision-making for policymakers. Capturing the full capabilities and benefits storage provides is needed to accurately assess the value of storage systems. Without this ability,

<sup>103</sup>Valuation analysis is used in many industries to determine the estimated value of a project, system component, or technology. There are a wide range of different valuation approaches for estimating the value of storage projects and the various services they provide to the grid.

assessments could undervalue energy storage and stall investments which could affect ratepayers and communities. Further, it will become increasingly important to properly value longer-duration energy storage systems as the grid transitions to greater amounts of deployed storage and as storage technologies mature, according to laboratory officials.

Quantifying energy storage value streams could increase the incentive for procuring, owning, and operating storage. This could be achieved by setting clear methodologies that allocate costs and benefits in the market and by providing long-term certainty storage services are compensated over the asset's lifetime. Investor risk-aversion toward novel longer-duration technologies could be mitigated through government support for early deployments. Lastly, longer-duration energy storage technologies may benefit from market designs and policies that capture the full value of such systems, as developers could receive profit from investing in longer-duration storage.

### Considerations

Energy storage technology value varies by region, and states approach the storage market differently. This variation has the potential to impact storage incentives and revenue streams. For example, the value of energy storage applications could vary from one utility to another depending on that area's regulations and local conditions. Specifically, a utility's grid assets factor into the value streams of energy storage, including how much value services such as resource adequacy, transmission deferral, and variable resource integration may have. Energy storage value could be realized by utilities that currently have or are looking to add

renewable energy to their systems. Greater storage deployment may be unlikely to occur without a government target or market demand to propel storage development forward, according to one stakeholder we interviewed.

Storage costs and benefits could be difficult to quantify and monetize. Underinvestment in storage because of an inability to fully account for costs and benefits can lead to suboptimal outcomes during the resource planning process. One expert highlighted the importance of valuing storage's environmental and social benefits, such as emissions reductions and incentives for the replacement of power plants located near disadvantaged communities. There are challenges with quantifying:

- **Resiliency benefits.** Storage provides resiliency benefits in avoiding energy outages that cause grid disruptions, but there may be limited metrics to assess these benefits.
- **Longer-duration storage.** Laboratory officials told us longer-duration storage systems may have limited value propositions—the provision of a defined grid service, measurable benefit to grid performance, revenue capture, or contribution to desired grid qualities—that make them more difficult to evaluate.

Incentives could lead to unintended outcomes for governments or developers. One storage type could dominate adoption over other technologies based on an increasing market share and drive out alternatives, otherwise known as technological “lock-in.” Stakeholders said incentives specifying one storage technology

could exclude other technologies or create a situation where outside developers have difficulty entering a market. Policies that support clean electric power deployment could be technology-neutral and include sunset provisions so they expire after a certain length of time to mitigate the potential for costs of incentives exceeding their benefits. Last, stakeholders may not believe financial assistance or other incentives are necessary, which could make reaching consensus on including incentives, like tax credits, in new storage policies more difficult.

## 5 Agency and Expert Comments

We provided a draft of this product to the Department of Energy, Department of the Interior, Energy Information Administration, Environmental Protection Agency, Federal Energy Regulatory Commission, and National Science Foundation with a request for technical comments. The Department of Energy, Department of the Interior, Energy Information Administration, Environmental Protection Agency, and Federal Energy Regulatory Commission provided us with technical comments, which we incorporated as appropriate. Officials from the National Science Foundation stated via email that they had no comments on the report.

We invited the participants from our meeting of experts to review our draft report. Of the experts, 12 agreed to receive the draft for review and technical comment, and we incorporated comments as appropriate.

---

We are sending copies of this report to the appropriate congressional committees and Secretaries of Energy and Interior; Chairman of the Federal Energy Regulatory Commission; Administrator of the Energy Information Administration; and the Director of the National Science Foundation, and other interested parties. In addition, the report is available at no charge on the GAO website at <http://www.gao.gov>.

If you or your staff have any questions about this report, please contact me at 202-512-6888 or [BothwellB@gao.gov](mailto:BothwellB@gao.gov). Contact points for our Offices of Congressional Relations and Public Affairs may be found on the last page of this report. GAO staff who made contributions to this report are listed in Appendix III.



Brian Bothwell  
Director  
Science, Technology Assessment,  
and Analytics

## ***List of Addressees***

**The Honorable Glenn “GT” Thompson**

Chairman

**The Honorable David Scott**

Ranking Member

Committee on Agriculture

House of Representatives

**The Honorable Frank Pallone**

Ranking Member

Committee on Energy and Commerce

House of Representatives

**The Honorable James Comer**

Chairman

Committee on Oversight and Accountability

House of Representatives

**The Honorable Frank Lucas**

Chairman

**The Honorable Zoe Lofgren**

Ranking Member

Committee on Science, Space, and Technology

House of Representatives

**The Honorable Martin Heinrich**

United States Senate

**The Honorable Mark Takano**

House of Representatives

## Appendix I: Objectives, Scope, and Methodology

We prepared this report under the authority of the Comptroller General to assist Congress with its oversight responsibilities, in light of broad congressional interest in utility-scale energy storage technologies. We examined (1) technologies that could be used to capture energy for later use within the electricity grid; (2) challenges that could impact energy storage technologies and their use on the grid; and (3) policy options that could help address energy storage challenges.

For the purposes of this review, we defined utility-scale energy storage as systems that have at least 1 megawatt of power output, have a centralized location and are therefore not distributed resources, and are on the utility's side of the meter and therefore not owned or operated by the consumer. Further, to be considered energy storage, systems should be capable of both receiving energy from the grid and storing it for later injection back to the grid. The minimum 1 megawatt of power output is consistent with the definition used by the Energy Information Administration, which collects annual and monthly data on electric power plants with 1 megawatt or greater of combined capacity.

To conduct our work across all three objectives, we selected pumped hydroelectric storage, lithium-ion batteries, emerging battery technologies such as flow batteries, compressed air energy storage, and flywheels as example energy storage technologies. We selected these technologies because they met our definition of utility-scale energy storage, were used on the grid as of March 2022, and maturity level. Based on these criteria, we did not include technologies such as hydrogen, liquid air energy storage, or concentrated solar thermal in our review. We do not discuss hydrogen because it was not

sufficiently established during our review, and concentrated solar thermal energy because it cannot take energy from the grid.

We interviewed officials from the Department of Energy, Department of the Interior, Energy Information Administration, Environmental Protection Agency, Federal Energy Regulatory Commission, and National Science Foundation. We also interviewed a non-generalizable sample of stakeholders from academia, non-governmental organizations, and industry, including finance and technology developers. Our interviews focused on utility-scale energy storage technology uses, applications, benefits, risks, challenges, and technology development activities. We selected stakeholders based on expertise in utility-scale energy storage technologies, understanding of technology benefits and challenges, or expertise in factors relevant to the development and adoption of utility-scale energy storage technologies, a review of relevant documents, if an entity was located in a selected state, and through obtaining recommendations from interviewees about others to contact.

We also interviewed state regulators about roles, energy storage technology deployment, planning, benefits and challenges, and technology development activities. We interviewed end users, such as electric power producers, on technology uses, applications, benefits, risks, challenges, and technology development activities. To help select state regulators and end users such as electric power producers, we selected a non-generalizable sample of seven states—California, Colorado, Florida, Massachusetts, Utah, Texas, and Wisconsin—based on regulatory scheme, renewable energy standard, involvement in an independent



system operator or regional transmission organization market, energy storage amount, and population density.<sup>104</sup> We selected power producers based on factors such as geographic location, energy storage technology use, technologies used, company size, and type. Our selection of interviewees is not representative of the views of all stakeholders but provides an illustrative range of views.

To inform all three research objectives, we reviewed agency-identified documents including a list of documents identified by the Department of Energy and its national laboratories on topics such as energy storage technologies, benefits, risks, and adoption challenges; peer-reviewed literature; white papers; and literature from the years 2015 to 2022 identified by a GAO librarian. The librarian searched a variety of databases including ProQuest, SCOPUS, and EBSCO using terms such as “utility-scale storage technology,” “grid-scale energy storage technology,” “application,” and “develop.” We selected the most relevant literature for further review based on our objectives.

In order to observe technologies and gain further insights, we conducted site visits to Colorado and Massachusetts. These sites were selected based on our state selection, energy storage facility presence, national laboratory facilities or other active ongoing research and development activities, and the availability of individuals or organizations to meet with us. We were able to see different energy storage technologies and talk with multiple stakeholders during our visits. The information gathered on the site visits does

not represent a generalizable sample of technologies or stakeholder views.

To obtain a range of perspectives on selected energy storage technology topics, we collaborated with the National Academies of Sciences, Engineering, and Medicine (National Academies) to convene a 1½ day meeting of a non-generalizable group of 15 experts from academia, government, non-governmental organizations, and industry. With assistance from the National Academies, we invited experts with expertise in (1) energy storage technologies, including researching the technologies, analyzing economic impacts, and evaluating environmental impacts; (2) acting as a policymaker or regulator; (3) manufacturing, operating a storage facility, or conducting cybersecurity work; and (4) managing energy storage on the grid. See appendix II for a list of experts who participated in our meeting. This meeting was held over 4 days, covering in four sessions, (1) selected economics topics, (2) benefits, (3) challenges, and (4) policy options. For each session, a GAO moderator posed open-ended questions to experts and facilitated the discussion within each topic area. At the beginning of sessions 2, 3, and 4, we asked experts to respond to poll questions about benefits, challenges, or policy options. The answers from these polls were used to identify the most commonly mentioned topics and to guide our discussion. We identified seven major policy options in advance of session 4 based on our review of literature and documents. During the meeting, we discussed the opportunities and considerations of each option in turn. When discussing each option, our moderator focused on the opportunities and

---

<sup>104</sup>One of the seven selected state regulators did not talk to us. However we did talk to another group that state regulator suggested we talk to. We did not contact an 8<sup>th</sup> state.

considerations presented by each option and which actions may or may not work to implement it.

We asked the experts who attended our meeting to identify any potential conflicts of interest, and we found the group of experts, as a whole, had no inappropriate biases. However, four of the experts did report potential conflicts of interest. These conflicts of interest were taken into consideration when analyzing and reporting expert statements. If we used comments from these four experts—in areas where these comments could present a conflict of interest—as evidence for potential findings, we corroborated this evidence with other sources. While this meeting was planned and convened with the assistance of the National Academies of Sciences, Engineering, and Medicine to better ensure that a breadth of expertise was brought to bear in its preparation, all final decisions regarding meeting substance and expert participation were the responsibility of GAO.

The expert meeting was not designed to produce a consensus among the experts who participated. Rather, it was designed to generate a range of experts' perspectives on each of the topics we discussed. As a result, experts may have agreed with each other on some points but disagreed with each other on other points. To clarify this distinction in the body of our report, we use phrasing such as "according to experts" to denote comments made by multiple experts without disagreement. We use phrasing such as "according to some experts" in cases where multiple experts made similar comments, but other experts disagreed.

Following the meeting, we continued to draw on the experts' expertise. For example, we held follow-up interviews with selected experts to learn more about topics discussed

during our expert meeting. We provided experts with the opportunity to review a draft of our report. At their request, experts received a draft of our report for review and technical comment, which we incorporated as appropriate.

For objective 1, in addition to the steps above, we collected and analyzed publicly accessible Energy Information Administration form 860 data for 2016 to 2021 on available energy storage technologies from generators with combined capacities of 1 megawatt or greater to determine information such as the amount of available capacity. For our analysis, we used and assessed data from the energy storage portion of the form 860 dataset, examining information on summer capacity and storage technologies. In order to determine the dataset's validity, we reviewed related documentation, interviewed officials knowledgeable about the dataset, and conducted data testing. Based on our review, we determined data to be sufficiently reliable for the purposes of our report. To estimate installed system cost information for the selected technologies, in dollars per kilowatt-hour, we reviewed national laboratory cost information and provided cost information from the most recent year available for 10

hour system durations, when available.<sup>105</sup> We also provided 4-hour system duration cost information, when available. In the reports we reviewed, flywheel data were provided for a 0.25-hour system duration, because flywheels are suitable for durations on the order of minutes. Because of this, we provide a 0.25-hour duration for flywheels. We selected these durations because data were available for multiple technologies, on an installed costs basis, for a 100 megawatt system. Different energy storage technology systems may be suitable for different system sizes and durations, but the reported system cost information represents the approach for which all system variables were kept as similar as possible.

For objective 3, we intend policy options to provide policymakers with a broader base of information for decision-making.<sup>106</sup> The options are not listed in any specific rank or order. We present five policy options and a status quo option in response to the factors identified during our work and discuss potential opportunities and considerations of each. While we present options to address the major challenges we identified and categorized, the options are not inclusive of all potential policy options that could be identified. The policy options and analyses were supported by the above evidence. Policy ideas—identified from our expert meeting, interviews, and document review—were categorized into policy options by combining similar ideas, could be grouped into a higher-

level policy option, were examples of how to implement a policy option, or did not fit into our scope. We grouped the remaining ideas based on themes (e.g., standards). From our analysis, we also assessed potential opportunities and considerations of implementing each policy option. To determine the opportunities and considerations that policymakers face in implementing policy options, we analyzed information from literature, documentation, interviews, and the meeting of experts. We then categorized the information by combining similar information from these sources in broader themes and verified each source within each theme.

To identify the types of energy storage efforts taken by states, we reviewed Department of Energy and Energy Information Administration documents from 2011-2022 to identify energy storage policies. Documents we reviewed included sources from websites of state energy offices; state public utility commissions; state legislatures; Comprehensive State Policy Analysis reports from the Global Energy Storage Database; State Profile and Energy Estimates and other reports from the Energy Information Administration; and reports from national laboratories, the Interstate Renewable Energy Council, and the National Conference of State Legislatures, during the time period covered by the documents we examined. There were 10 states with a Comprehensive Policy Analysis report from the Department of

---

<sup>105</sup>For pumped hydroelectric storage, lithium ion batteries, flow batteries, and compressed air energy storage, 2022 cost information is provided. Pacific Northwest National Laboratory for the U.S. Department of Energy, *2022 Grid Energy Storage Technology Cost and Performance Assessment* (Aug 2022). For flywheels, 2019 cost information is provided. Pacific Northwest National Laboratory for the U.S. Department of Energy, *Energy Storage Technology and Cost Characterization Report* (July 2019).

<sup>106</sup>Policymakers is a broad term including, for example, Congress, elected officials, federal agencies, regulators, state and local governments, academic and research institutions, and industry.

Energy and states without this report were supplemented with the other source documents listed. State storage efforts were then matched to the following definitions as determined by document and website review: states that (1) assessed or explored storage; (2) clarified rules or regulations pertaining to energy storage; (3) provided incentives for storage; and (4) included storage in strategic grid modernization plans. We identified states that assessed or explored storage (1) contained support for a renewable portfolio standard or the state public utility commission or energy office held a general assessment, workshop, or briefing on energy storage in the documents we reviewed. States that had clarified storage related rules or regulations (2) contained support for interconnection, net metering, permitting codes, or energy storage definitions in documents we reviewed. States that had provided incentives for storage (3) contained support for facilitated market growth through procurement targets, pilot projects, mandates, or other incentives in documents we reviewed. Last, states that had included storage into strategic grid modernization plans (4) contained support for integrating energy storage into grid modernization and

planning decisions, such as through long-term planning, optimization, or system planning in documents we reviewed. If a state had taken actions related to energy storage that were not reflected in the documents we reviewed or were outside the time period, they would not be included in our analysis. Consequently, the results of this analysis are intended to broadly characterize the range of efforts taken by states rather than to precisely categorize the efforts taken by any individual state or to evaluate the extent of the efforts taken.

We conducted our work from December 2021 to March 2023 in accordance with all sections of GAO's Quality Assurance Framework that are relevant to technology assessments. The framework requires that we plan and perform the engagement to obtain sufficient and appropriate evidence to meet our stated objectives and to discuss any limitations to our work. We believe that the information and data obtained, and the analysis conducted, provide a reasonable basis for any findings and conclusions in this product.

## Appendix II: Expert Participation

With the assistance of the National Academies of Sciences, Engineering, and Medicine, we convened a meeting of experts to inform our work on utility-scale energy storage. The meeting was held virtually on September 6–9, 2022. The 15 experts who participated in this meeting are listed below. These experts gave us additional assistance throughout our work, including 12 experts who agreed to review our draft report for accuracy and provide technical comments.

### **Robert “Bobby” Bailie**

Sales Manager – Transformation of Industry  
Siemens Energy

### **Anjan Bose**

Regents Professor  
Washington State University

### **Yet-Ming Chiang**

Kyocera Professor  
Massachusetts Institute of Technology

### **Michael Craig**

Assistant Professor  
School for Environment and Sustainability,  
Department of Industrial and Operations  
Engineering  
University of Michigan

### **Paul Denholm**

Principal Energy Analyst  
National Renewable Energy Laboratory

### **Gregory Falco**

Assistant Professor of Space Technology and  
Security  
Johns Hopkins University

### **John Fernandes**

Senior Consultant – Emerging Technologies  
Customized Energy Solutions

### **Howard Gruenspecht**

Senior Energy Economist  
Massachusetts Institute of Technology

### **Colette Honorable**

Partner  
Reed Smith LLP

### **Elena Krieger**

Director of Research  
PSE Healthy Energy

### **Judy Jeevarajan**

Vice President and Executive Director of  
Electrochemical Safety Research Institute  
UL Research Institutes

### **Mark G. Lauby**

Senior Vice President and Chief Engineer  
North American Electric Reliability Corporation

### **Marianne Perben**

Director of Planning Services  
Independent System Operator – New England

### **Seth Sanders**

Professor Emeritus  
University of California, Berkeley

### **Nestor A. Sepulveda**

Engagement Manager  
McKinsey & Company  
Energy Systems  
Massachusetts Institute of Technology

## Appendix III: GAO Contacts and Staff Acknowledgments

### GAO contacts

**Brian Bothwell, MS**, Director, Science, Technology Assessment, and Analytics, at (202) 512-6888 or [bothwellb@gao.gov](mailto:bothwellb@gao.gov)

### Staff acknowledgments

In addition to the contact named above, the following staff made key contributions to this report:

**William Carrigg, MS**, Assistant Director and Senior Systems Analyst  
**Charlotte E. Hinkle, PhD**, Analyst-in-Charge and Senior Physical Scientist  
**Katherine Chambers, PhD**, Physical Scientist  
**Philip Farah, PhD**, Assistant Director and Senior Economist  
**Patrick Harner, JD**, Senior Attorney  
**Anika McMillon**, Visual Communications Analyst  
**AJ Melhus, MS**, Senior General Engineer  
**George Nelson, MS**, Physical Scientist  
**Marshal Pennock, MPA**, Analyst  
**Ben Shouse**, Communications Analyst  
**Jack Wang, PhD**, Senior Economist  
**Wes Wilhelm, MS**, Senior Systems Engineer

---

## GAO's Mission

The Government Accountability Office, the audit, evaluation, and investigative arm of Congress, exists to support Congress in meeting its constitutional responsibilities and to help improve the performance and accountability of the federal government for the American people. GAO examines the use of public funds; evaluates federal programs and policies; and provides analyses, recommendations, and other assistance to help Congress make informed oversight, policy, and funding decisions. GAO's commitment to good government is reflected in its core values of accountability, integrity, and reliability.

---

## Obtaining Copies of GAO Reports and Testimony

The fastest and easiest way to obtain copies of GAO documents at no cost is through GAO's website (<https://www.gao.gov>). Each weekday afternoon, GAO posts on its website newly released reports, testimony, and correspondence. To have GAO e-mail you a list of newly posted products, go to <https://www.gao.gov> and select "E-mail Updates."

---

## Order by Phone

The price of each GAO publication reflects GAO's actual cost of production and distribution and depends on the number of pages in the publication and whether the publication is printed in color or black and white. Pricing and ordering information is posted on GAO's website, <https://www.gao.gov/ordering.htm>.

Place orders by calling (202) 512-6000, toll free (866) 801-7077, or TDD (202) 512-2537.

Orders may be paid for using American Express, Discover Card, MasterCard, Visa, check, or money order. Call for additional information.

---

## Connect with GAO

Connect with GAO on [Facebook](#), [Flickr](#), [Twitter](#), and [YouTube](#).

Subscribe to our [RSS Feeds](#) or [E-mail Updates](#).

Listen to our [Podcasts](#) and read [The Watchblog](#).

Visit GAO on the web at <https://www.gao.gov>.

---

## To Report Fraud, Waste, and Abuse in Federal Programs

Contact: Website: <https://www.gao.gov/fraudnet/fraudnet.htm>

Automated answering system: (800) 424-5454 or (202) 512-7470

---

## Congressional Relations

A. Nicole Clowers, Managing Director, [ClowersA@gao.gov](mailto:ClowersA@gao.gov), (202) 512-4400,  
U.S. Government Accountability Office, 441 G Street NW, Room 7125, Washington, DC 20548

---

## Public Affairs

Chuck Young, Managing Director, [YoungC1@gao.gov](mailto:YoungC1@gao.gov), (202) 512-4800  
U.S. Government Accountability Office, 441 G Street NW, Room 7149, Washington, DC 20548

---

## Strategic Planning and External Liaison

Stephen Sanford, Managing Director, [spel@gao.gov](mailto:spel@gao.gov), (202) 512-9715  
U.S. Government Accountability Office, 441 G Street NW, Room 7B37N, Washington, DC 20548