



December 2017

COLUMBIA CLASS SUBMARINE

Immature
Technologies Present
Risks to Achieving
Cost, Schedule, and
Performance Goals

Accessible Version

Why GAO Did This Study

The Navy's Columbia class ballistic missile submarines will replace the 14 Ohio class that currently provide the sea-based leg of the U.S. nuclear triad, slated to begin retiring in 2027. The first Columbia must begin patrols in 2031 to prevent a gap in deterrent capabilities; the class will ultimately carry up to 70 percent of the nation's strategic nuclear capability. The program is a top Navy priority with an expected cost of \$267 billion over its life cycle, including \$128 billion to research, develop, and buy 12 submarines.

House Report 114-102 included a provision for GAO to examine the Columbia class program. Among other things, this review examines (1) the status of key Columbia class technologies; and (2) potential risks with the Navy's planned approach for design and construction.

GAO reviewed the Navy's technology readiness assessment, technology development plan, and the status of key prototyping efforts, and compared efforts with GAO's identified best practices for shipbuilding programs and technology readiness assessments. GAO also assessed the status of design maturity and the Navy's acquisition strategy and interviewed relevant officials.

What GAO Recommends

GAO had suggested a matter for congressional consideration related to additional reporting on the Columbia class technologies, but removed it because of recent legislation that implements this requirement. Department of Defense comments on the draft were incorporated as appropriate in this report.

View [GAO-18-158](#). For more information, contact Shelby S. Oakley at (202) 512-4841 or oakleys@gao.gov

COLUMBIA CLASS SUBMARINE

Immature Technologies Present Risks to Achieving Cost, Schedule, and Performance Goals

What GAO Found

Additional development and testing are required to demonstrate the maturity of several Columbia class submarine technologies that are critical to performance, including the Integrated Power System, nuclear reactor, common missile compartment, and propulsor and related coordinated stern technologies (see figure). As a result, it is unknown at this point whether they will work as expected, be delayed, or cost more than planned. Any unexpected delays could postpone the deployment of the lead submarine past the 2031 deadline.

Further, the Navy underrepresented the program's technology risks in its 2015 Technology Readiness Assessment (TRA) when it did not identify these technologies as critical. Development of these technologies is key to meeting cost, schedule, and performance requirements. A reliable TRA serves as the basis for realistic discussions on how to mitigate risks as programs move forward from the early stages of technology development. Not identifying these technologies as critical means Congress may not have had the full picture of the technology risks and their potential effect on cost, schedule, and performance goals as increasing financial commitments were made. The Navy is not required to provide Congress with an update on the program's progress, including its technology development efforts, until fiscal year 2020—when \$8.7 billion for lead ship construction will have already been authorized. Periodic reporting on technology development efforts in the interim could provide decision makers assurances about the remaining technical risks as the Navy asks for increasing levels of funding.

Columbia Class Submarine Critical Technologies

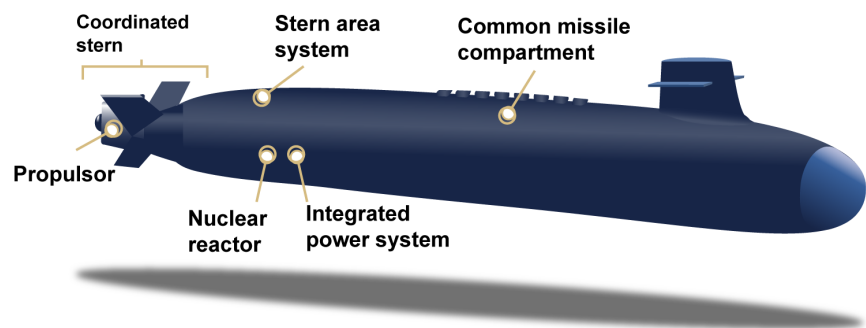

Source: GAO analysis of of Navy documentation. | GAO-18-158

Consistent with GAO's identified best practices, the Navy intends to complete much of the submarine's overall design prior to starting construction to reduce the risk of cost and schedule growth. However, the Navy recently awarded a contract for detail design while critical technologies remain unproven—a practice not in line with best practices that has led to cost growth and schedule delays on other programs. Proceeding into detail design and construction with immature technologies can lead to design instability and cause construction delays. The Navy plans to accelerate construction of the lead submarine to compensate for an aggressive schedule, which may lead to future delays if the technologies are not fully mature before construction starts, planned for 2021.

Contents

Letter		1
	Background	3
	Major Funding Commitments Planned, but Reporting on the Progress of Several Key Immature Technologies Is Not Required	20
	The Navy Plans to Leverage Completed Design to Mitigate Aggressive Schedule, but Ongoing Technology Development Likely to Undermine This Goal	33
	Columbia Class Is Not Funded Adequately to Address Program Risks	41
	Conclusions	45
	Matter for Congressional Consideration	46
	Agency Comments and our Evaluation	47
<hr/>		
Appendix I: Objectives, Scope, and Methodology		51
Appendix II: Department of Defense Technology Readiness Levels		54
Appendix III: Comments from the Department of Defense		55
	GAO Comments	59
<hr/>		
Appendix IV: GAO Contact and Staff Acknowledgments		61
	GAO Contact	61
	Staff Acknowledgments	61
<hr/>		
Appendix V: Accessible Data		62
	Data Tables	62
	Agency Comment Letter	64
<hr/>		
Tables		
	Table 1: Technology Readiness Levels (TRL)	18
	Table 2: Comparison of Criteria for Identifying Critical Technology Elements (CTE)	27

Table 3: Assessment of Columbia Class Key Technology Efforts Using GAO's Critical Technology Element (CTE) Criteria	29
Table 4: Department of Defense Technology Readiness Levels (TRL) ⁵⁴	

Figures

Figure 1: The United States Nuclear Triad	4
Figure 2: Responsible Parties and Key Components of Columbia Class Submarine	6
Figure 3: Columbia Class Submarine Key Technical Efforts	7
Figure 4: Notional Columbia Class Submarine Common Missile Compartment	9
Figure 5: Comparison of Nuclear Mechanical Drive with Nuclear Electric Drive	10
Figure 6: Notional Depiction of Major Components of the Columbia Class Coordinated Stern	12
Figure 7: Overview of Columbia Class Life-Cycle Cost Estimate (Then-Year Dollars, Millions)	13
Figure 8: Acquisition Plans for the Columbia Class Submarine (in calendar year)	14
Figure 9: Acquisition Framework for Columbia Class Submarine Program	15
Figure 10: Comparison of Design Phases for Columbia Class Submarine and Typical Surface Ships	17
Figure 11: GAO Assessment of Maturity of Columbia Class Critical Technologies (as of November 2017)	22
Figure 12: Concurrency of Navy Technology Development and Detail Design and Lead Ship Construction	37
Figure 13: Estimated and Actual Schedules for U.S. Navy Lead Submarines (months)	39
Figure 14: Plans for Early Start of Lead Columbia Construction Focus on Critical Areas	40
Figure 15: Cost Growth in Program Budgets for the Three Lead Navy Submarines Authorized to Start Construction since 1989	44
Accessible Data for Figure 1: The United States Nuclear Triad	62
Accessible Data for Figure 7: Overview of Columbia Class Life-Cycle Cost Estimate (Then-Year Dollars, Millions)	62
Accessible Data for Figure 8: Acquisition Plans for the Columbia Class Submarine (in calendar year)	62

Accessible Data for Figure 13: Estimated and Actual Schedules for U.S. Navy Lead Submarines (months)	63
Accessible Data for Figure 15: Cost Growth in Program Budgets for the Three Lead Navy Submarines Authorized to Start Construction since 1989	63

Abbreviations

CAPE	Office of the Secretary of Defense Cost Analysis and Program Evaluation
CBO	Congressional Budget Office
CMC	Common Missile Compartment
CTE	Critical Technology Element
DOD	Department of Defense
DOE	Department of Energy
GFI	Government Furnished Information
IPS	Integrated Power System
NASA	National Aeronautics and Space Administration
OSD	Office of the Secretary of Defense
SAS	Stern Area System
SSBN	Nuclear-powered ballistic missile submarine
STRATCOM	United States Strategic Command
TRA	Technology Readiness Assessment
TRL	Technology Readiness Level
VFI	Vendor Furnished Information

This is a work of the U.S. government and is not subject to copyright protection in the United States. The published product may be reproduced and distributed in its entirety without further permission from GAO. However, because this work may contain copyrighted images or other material, permission from the copyright holder may be necessary if you wish to reproduce this material separately.



December 21, 2017

Congressional Committees

The Navy plans to buy 12 Columbia class nuclear-powered ballistic missile submarines (called SSBNs) armed with nuclear warheads as the replacement to the Ohio class, the current sea-based leg of the nation's strategic nuclear deterrent. The Columbia class fleet will replace the 14 Ohio class SSBNs as they begin to retire in 2027 after over 42 years, longer than any prior class of submarine. The Navy plans to use new technologies related to submarine propulsion, missile tubes, and stealth to ensure that the Columbia class will remain functional throughout its planned 42.5-year service life. The Navy has identified the Columbia class program as its top acquisition priority and is investing significantly in this effort—approximately \$267 billion (then-year dollars) in total, including \$128 billion (then-year dollars) to research, develop, and buy 12 submarines.¹ In fiscal year 2017, the Navy began buying materials and starting detail design, with plans to begin construction of the lead submarine in fiscal year 2021. To avoid a gap in the nation's sea-based deterrent as the Ohio class SSBNs retire, the lead ship will need to make its first patrol in fiscal year 2031. Given the criticality of the program's deterrence mission and the magnitude of the cost and schedule pressures, any challenges could have far-reaching consequences for the nation's defense.

In light of the Columbia class investment requirements, the House Armed Services Committee report for the National Defense Authorization Act for Fiscal Year 2016 included a provision that we examine the program. This report examines (1) the status of key Columbia class technologies and related reporting requirements; (2) risks, if any, with the Navy's planned approach for design and construction; and (3) whether expected funding levels for the Columbia class will be adequate moving forward.

¹This \$128 billion represents the total acquisition cost, including test and evaluation, and military construction costs. The Navy estimates that approximately \$140 billion will be needed to operate and sustain the submarines over their life cycle. Then-year dollars reflect the effects of inflation, including escalation up to and during the year of the appropriation, and throughout the period during which dollars are expended from the Treasury.

To assess the status of development of key Columbia class technologies, we reviewed the Navy's technology development plan and the status of key prototyping efforts, and compared them with GAO's identified best practices for shipbuilding programs. We also reviewed the program's Technology Readiness Assessment and compared it to criteria in GAO's Technology Readiness Assessment guide.² GAO's guide draws heavily from the Department of Defense (DOD), Department of Energy (DOE), and National Aeronautics and Space Administration (NASA) best practices, and establishes a methodology based on those best practices that can be used across the federal government for evaluating technology maturity, particularly as it relates to determining a program or project's readiness to move past key decision points that typically coincide with major commitments of resources. We interviewed Navy officials and analyzed available documentation related to the Navy's technical efforts. We also examined acquisition laws, regulations, and policies to determine the reporting requirements for the Columbia class program following the program's Milestone B decision, which occurred in January 2017.

To assess the risks, if any, with the Navy's planned approach for design and construction of the Columbia class, we compared the status of design maturity with Navy and shipyard plans to identify any delays. We also compared planned design maturity and schedule projections with those of prior U.S. submarine programs to assess realism of these estimates. We assessed the program's acquisition strategy, including plans to accelerate the start of submarine construction and manage shipyard workload across the Columbia and ongoing Virginia class submarine programs (which will be built in the same shipyards) to identify factors related to potential cost, schedule, and oversight risks. Our assessment leverages, among other things, our prior work on shipbuilding programs.³

To assess whether expected funding levels for the Columbia class will be adequate moving forward, we compared program cost estimates to

²GAO, *Technology Readiness Assessment Guide: Best Practices for Evaluating the Readiness of Technology for Use in Acquisition Programs and Projects*, [GAO-16-410G](#) (Washington, D.C.: August 2016).

³GAO, *Ford Class Aircraft Carrier: Poor Outcomes Are the Predictable Consequences of the Prevalent Acquisition Culture*, [GAO-16-84T](#) (Washington D.C. Oct. 1, 2015); *Best Practices: High Levels of Knowledge at Key Points Differentiate Commercial Shipbuilding from Navy Shipbuilding*, [GAO-09-322](#) (Washington D.C. May 13, 2009); and *Defense Acquisitions: Improved Management Practices Could Help Minimize Cost Growth in Navy Shipbuilding Programs*, [GAO-05-183](#) (Washington D.C. Feb. 28, 2005).

historical data on lead ship cost performance and the Navy's expected budget for the program to assess the realism of these estimates. We also reviewed the program's life-cycle cost estimate and independent cost estimate.

For all objectives, we interviewed officials from the Navy's Columbia class submarine program office; the Office of the Chief of Naval Operations-Undersea Warfare; Naval Sea Systems Command Naval Nuclear Propulsion Program; Naval Undersea Warfare Center; Naval Surface Warfare Center Carderock Division; Office of the Secretary of Defense (OSD) Director Operational Test and Evaluation; Office of Naval Intelligence; OSD Acquisition Technology and Logistics (AT&L); OSD Cost Analysis and Program Evaluation (CAPE); and the prime contractor shipyard General Dynamics Electric Boat and its sub-contractor Huntington Ingalls Industries Newport News Shipbuilding, among others.

Appendix I presents a more detailed description of the scope and methodology of our review.

We conducted this performance audit from May 2016 to December 2017 in accordance with generally accepted government auditing standards. Those standards require that we plan and perform the audit to obtain sufficient, appropriate evidence to provide a reasonable basis for our findings and conclusions based on our audit objectives. We believe that the evidence obtained provides a reasonable basis for our findings and conclusions based on our audit objectives.

Background

The U.S. strategic nuclear deterrent is spread among three legs, as depicted in figure 1.

Figure 1: The United States Nuclear Triad

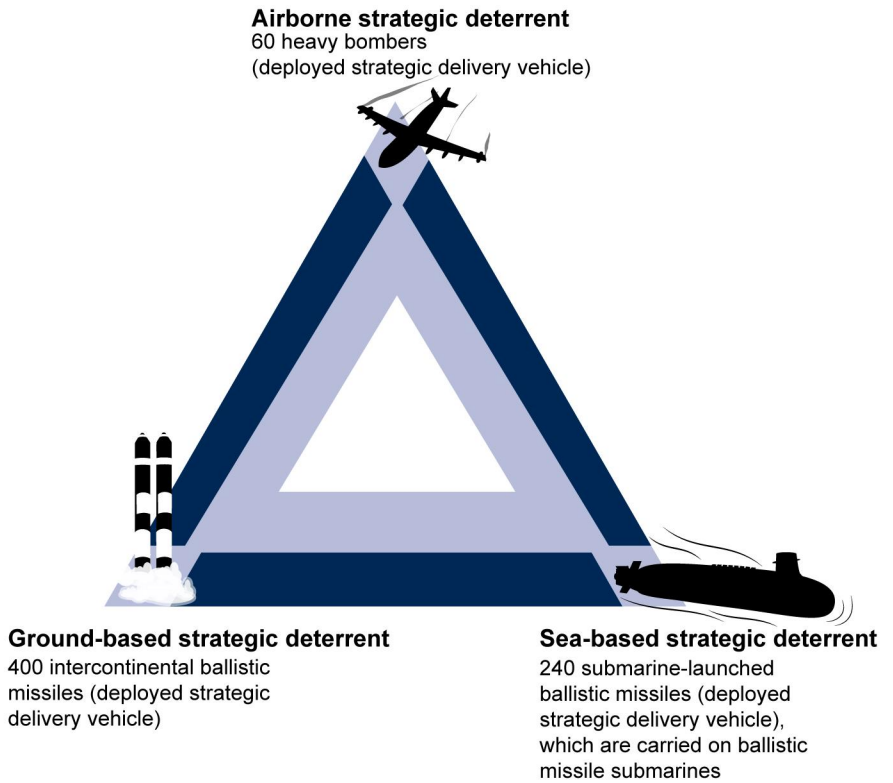

Source: GAO analysis of Department of Defense documents. | GAO-18-158

DOD has continued to reinforce the high priority of the Columbia class program to the nation's long-term defense. SSBNs are designed to maximize stealth to remain undetected while on patrol at sea. This survivability gives the United States a credible ability to retaliate if faced with an attack targeting other legs of the triad, and explains DOD's decision to ultimately deploy up to 70 percent of the nation's nuclear warheads on SSBNs.

As stated in its April 2010 *Nuclear Posture Review Report*, DOD determined that ensuring a survivable U.S. deterrent requires continuous at-sea deployments of SSBNs in both the Atlantic and Pacific oceans, as well as the ability to surge additional submarines in crisis. Currently, 14 Ohio class SSBNs provide the sea-based strategic deterrent. The Navy

commissioned the lead ship of this fleet in 1981.⁴ The first Ohio class SSBN to retire—SSN 730—will leave service in 2027 and plans are to retire one per year following this. When these submarines retire, they will have been in service over 40 years, longer than any previous submarines.⁵ Navy officials have stated that the legacy Ohio fleet cannot be life-extended any longer than what is planned due to aging issues.

The U.S. Strategic Command (STRATCOM) retains operational control of the strategic triad and determines how many SSBNs are needed to patrol on a day-to-day basis. STRATCOM and the Navy have determined that 10 operationally available SSBNs are needed to meet mission requirements. As a result, the lead Columbia class submarine must be available for its first deterrent patrol in the first quarter of fiscal year 2031 to coincide with the planned 2031 retirement of SSN 734, or the Navy will not have 10 operationally available SSBNs, thereby requiring DOD to identify other steps to ensure it can meet current deterrent requirements.

The Navy expects that it can meet mission requirements with 12 Columbia class submarines carrying 16 missile tubes (equating to a total of 192 available tubes) in lieu of 14 Ohio class submarines carrying 24 tubes (336 total available tubes). Currently, it takes 14 Ohio class submarines to provide 10 operationally available SSBNs due to maintenance needs that can take up to 4 submarines out of the patrol rotation at any given time. The Navy plans to reduce the number and duration of required maintenance periods for the Columbia class, allowing just 12 Columbia class submarines to provide the required 10 operational submarines at all times. Between fiscal year 2031-2040, the Navy plans to have a mix of 10 operationally available Columbia and Ohio class submarines. In fiscal year 2041, with the retirement of the final Ohio class submarine, this is to increase to 11 Columbia class, and finally to 12 operationally available Columbia class submarines by fiscal year 2042.⁶

⁴Originally, 18 Ohio class were built, but the first 4 were converted into conventionally armed guided missile submarines in the early 2000s. The conversion process started in 2002 and ended in 2007.

⁵The other legs of the triad are also aging. DOD is currently embarked on separate efforts to recapitalize each leg of the triad, with investments in the Columbia class SSBN, a new Ground-Based Strategic Deterrent intercontinental ballistic missile, and the B-21 strategic long-range strike bomber. We have ongoing work assessing the status of these additional efforts.

⁶The final Ohio class submarine is slated to retire in 2039.

Columbia Class Technology Efforts

The Columbia class program is comprised of several major lines of effort—hull and supporting systems, the strategic weapons system; and the nuclear reactor-based propulsion plant—which are managed by different program offices, as depicted in figure 2.

Figure 2: Responsible Parties and Key Components of Columbia Class Submarine

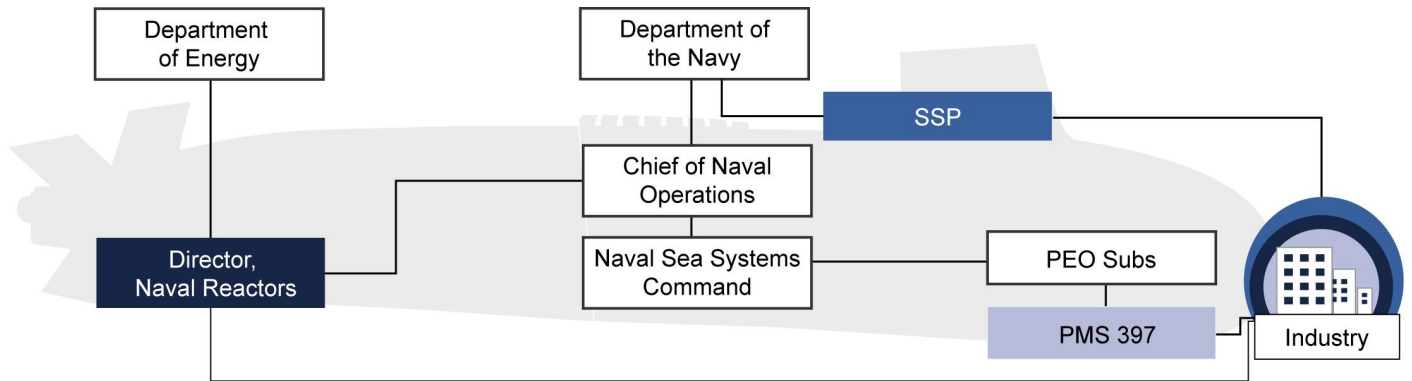

Naval Reactors (NAVSEA 08)



Established by executive order and statute, Naval Reactors is part of Naval Sea Systems Command but receives funding and authority from both the Departments of Energy and the Navy and operates in coordination with but independently from the Navy program offices it supports.

Responsible for the design and production of the Columbia class nuclear reactor-based propulsion system including life-of-ship reactor and electric drive system.

Strategic Systems Program (SSP)



Navy office responsible for developing and maintaining the Navy's strategic nuclear deterrent and ensuring nuclear weapons security.

Responsible for providing a complete, working strategic weapons system to the shipyard, including the Trident II D-5 submarine launched ballistic missile and related launch equipment including navigation and instrumentation.

Program Manager, Ships 397 (PMS 397)



Part of Program Executive Office (PEO), Submarines, PMS 397 is the program office responsible for program management of the acquisition of the Columbia class.

Coordinates research, development, design, and production of the submarine. Responsible for the submarine's hull, mechanical, and electrical systems, including life-support and some non-nuclear propulsion equipment. Oversees the activities of the contractors, including General Dynamics Electric Boat in Groton Connecticut and Quonset Point, Rhode Island (the lead shipyard) and Huntington Ingalls Industries Newport News Shipbuilding in Newport News, Virginia (the main subcontractor).

Source: GAO analysis of Navy documents. | GAO-18-158

The Navy is introducing new technologies to improve capabilities where required while leveraging systems from existing submarine programs—the Virginia and Seawolf attack submarines and the Ohio class SSBNs—in order to ensure commonality with the submarine fleet and reduce development needs for the Columbia class to limit technical risk. For

example, the program is re-using over 19,000 Virginia class standard parts including fittings, valves, and switches and leveraging the Navy's Submarine Warfare Federated Tactical System program, which integrates more than 40 independent electronics systems into a common combat system for use by multiple program offices.

The Navy has identified several key technical efforts for the Columbia class program: (1) the Common Missile Compartment, (2) Integrated Power System, (3) Stern Area System, and (4) propulsor. Other systems that we consider key technical efforts include the nuclear reactor and the coordinated stern, a system-of-systems that includes the propulsor and submarine maneuvering components. These areas are depicted in Figure 3 and defined below.

Figure 3: Columbia Class Submarine Key Technical Efforts

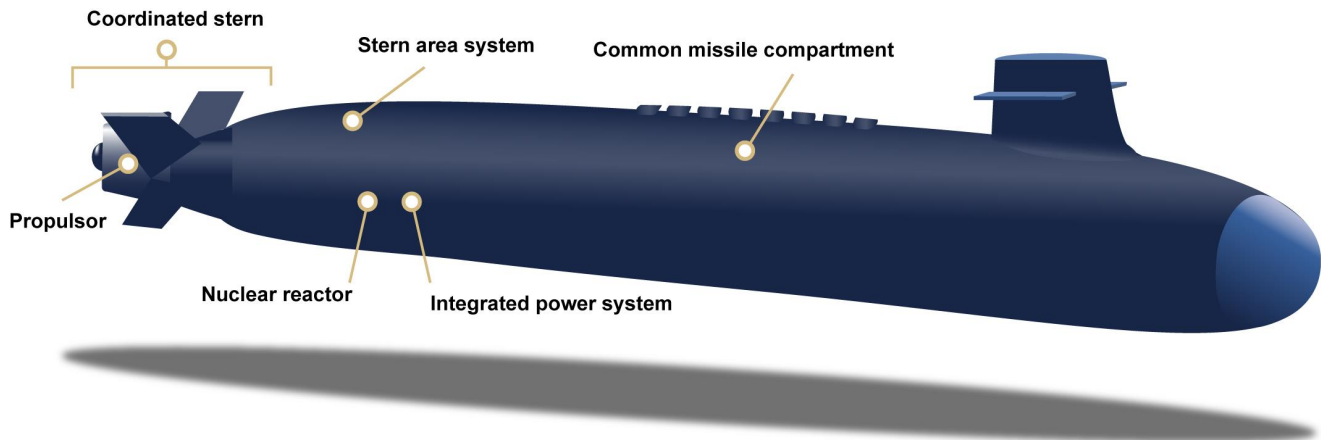

Source: GAO analysis of Navy documentation. | GAO-18-158

Common Missile Compartment (CMC)

Since 2008, the United States and the United Kingdom (U.K.) have been jointly developing a common system to house the tubes that will carry

submarine launched ballistic missiles.⁷ Columbia class SSBNs and U.K. SSBNs will carry the Trident II D-5 missile for the first portion of their respective operational lives; the U.S. missiles armed with nuclear warheads which are maintained by the Department of Energy (DOE).⁸ Figure 4 shows a notional example of the CMC.

⁷The United Kingdom is developing a replacement to its Vanguard class SSBN; this class is scheduled to retire before the Columbia class. The United States and United Kingdom have cooperated on SSBNs since the signature of the 1963 Polaris Sales Agreement, whereby the U.S. agreed to sell submarine launched ballistic missiles and the accompanying launch subsystems (less warheads) to the United Kingdom for use on its indigenously built nuclear-powered SSBNs. In 1980, the United Kingdom requested and was granted approval for sale of Trident I missiles (less warheads) and equipment; in 1982 the agreement was again leveraged to sell the United Kingdom the updated Trident II (D5) missile in order to maintain commonality with the United States.

⁸Ohio class SSBNs carry the Trident II D-5 missile, which has been in operation for over 25 years. The Navy initiated a life extension program in 2002 to extend the service life to 45 years, or 2042. The Navy plans for an eventual replacement for the D-5 Trident II but specifics have not yet been determined. There are separate efforts underway or recently completed to refurbish and extend the life of the nuclear warheads and reentry systems for an additional 30 years. These upgrade programs are being executed in partnership with the DOE National Nuclear Security Administration.

Figure 4: Notional Columbia Class Submarine Common Missile Compartment

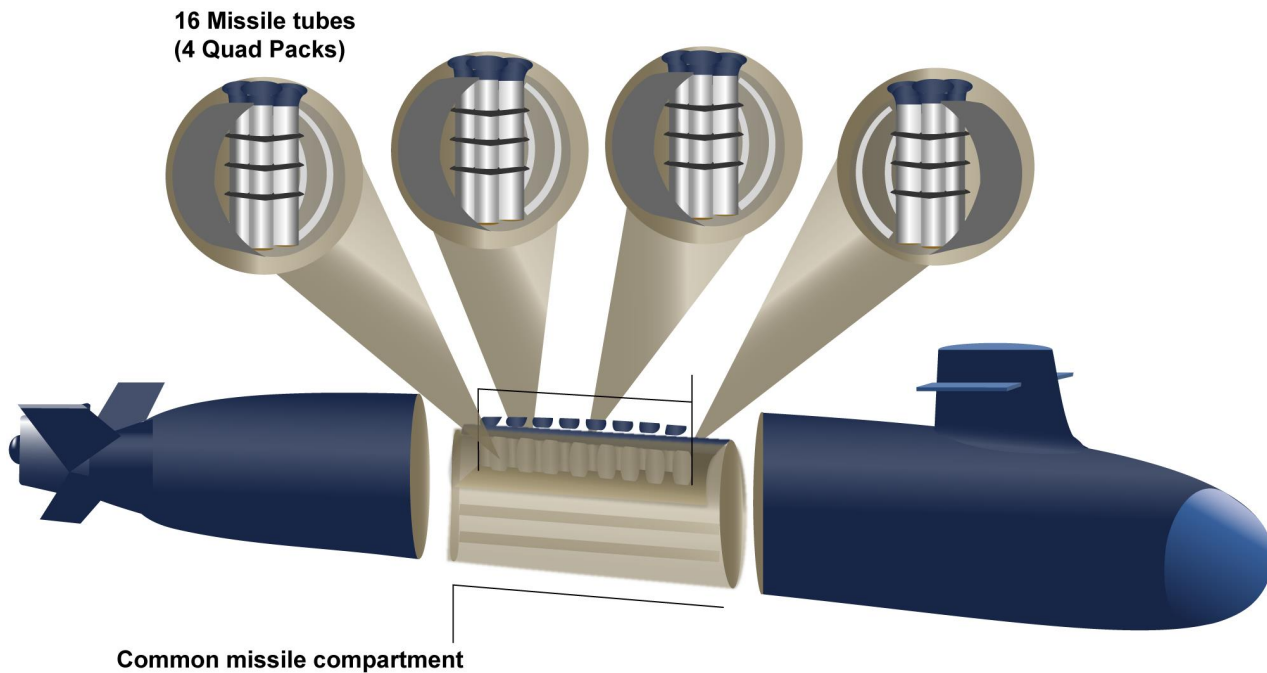

Source: GAO analysis of Navy documentation. | GAO-18-158

In addition to the missile tubes, the CMC also provides systems to support the missiles and the launch equipment, including power, cooling, gas venting, and launch hardware and software. The Navy's Strategic Systems Program is responsible for CMC development efforts.

Integrated Power System (IPS) and Nuclear Reactor

The IPS includes an electric drive system to propel the submarine through the water, unlike other current U.S. submarines which use a mechanical drive system. IPS is powered by the nuclear reactor, which is a separate system. As shown in figure 5, with a nuclear electric drive system, steam from the nuclear reactor turns a turbine creating electricity, which is then directly used to power electric motors. This is in contrast with a nuclear mechanical propulsion system, where steam from the nuclear reactor turns a turbine creating high-speed rotation; a reduction gear then slows the speed of this rotation to a speed that is suitable for use by the propulsor.

Figure 5: Comparison of Nuclear Mechanical Drive with Nuclear Electric Drive

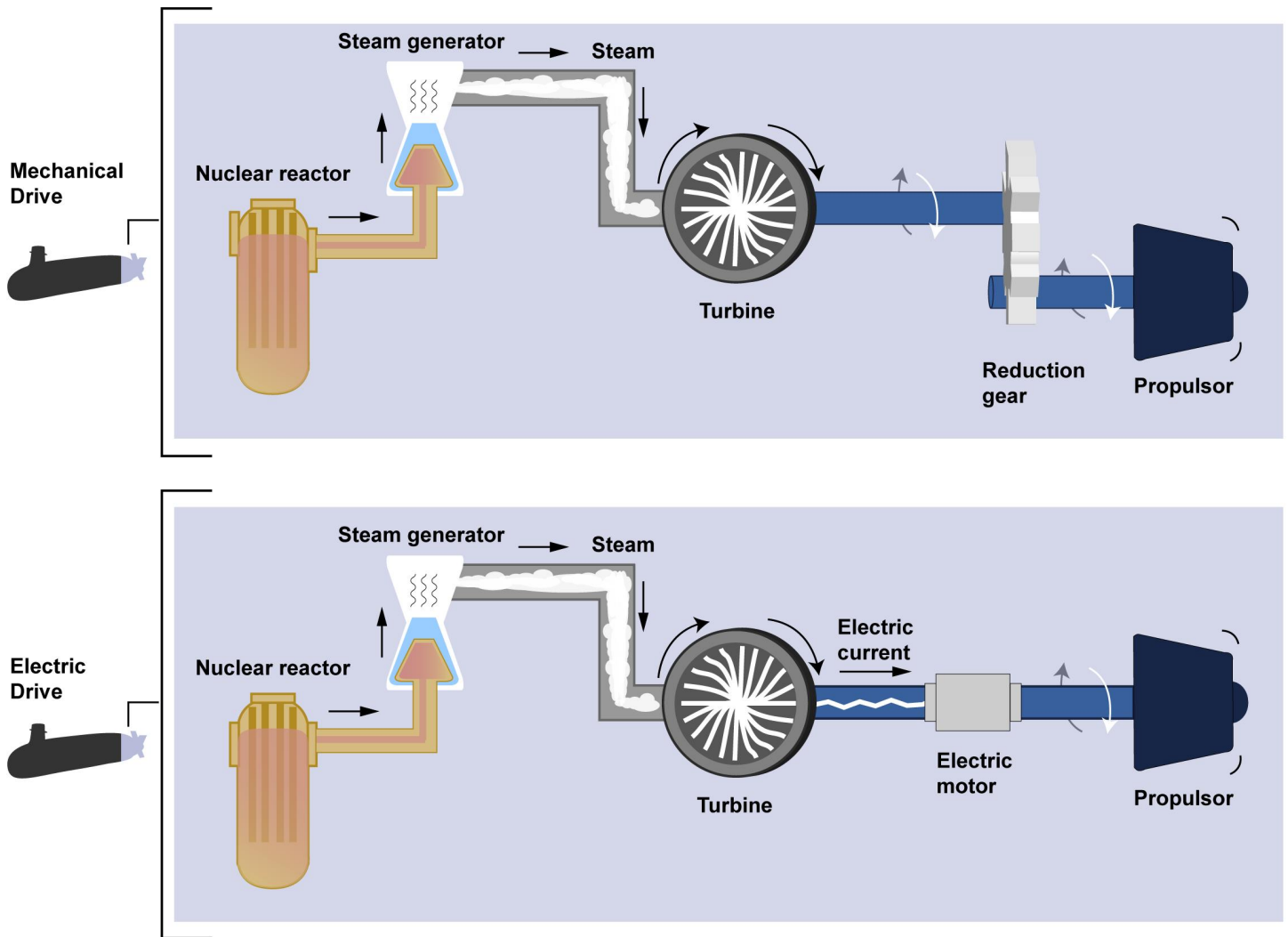

Source: GAO analysis of Navy documentation. | GAO-18-158

To provide power to the electric drive, the Columbia class nuclear propulsion plant relies on a life-of-the-ship reactor core—called S1B—that is planned to remain in service without refueling, almost 10 years longer than current U.S. Navy nuclear reactors. The Virginia class also uses a life-of-the-ship reactor core, but the Columbia class reactor needs to be more powerful to drive the larger submarine, and needs to last longer to allow for the 42.5-year Columbia class service life of versus 33 years for the Virginia class. By using a life-of-the-ship reactor, the Columbia class will not require a mid-life refueling. This will reduce the mid-life

maintenance period from 27 months for Ohio class to 16 months for Columbia class. This reactor is being developed by the Naval Nuclear Propulsion Program (also known as Naval Reactors) and the Naval Nuclear Laboratory (operated by Bechtel Marine Propulsion Corporation).

Stern Area System (SAS)

SAS is a technical feature of the stern that is comprised of three subcomponents; details of which are classified.

Propulsor/Coordinated Stern

The Columbia class will use a propulsor instead of a propeller to drive the submarine through the water. The design of the propulsor relies on several other technical features that form a system-of-systems, sometimes referred to as the coordinated stern. The coordinated stern is where the rudder and other control surfaces are mounted; these control surfaces are used for submarine maneuvering and are critical to submarine performance. The coordinated stern consists of interrelated technology elements, including the propulsor and advanced propulsor bearing, the stern control surface configuration, and the propulsor shaft and bearing.

The propulsion shaft and bearing connects the propulsion system to the propulsor, transferring energy from the propulsion system to the propulsor to drive the submarine through the water. The Navy plans to use a new design "X-stern" configuration instead of the cruciform stern used in other submarines. Figure 6 depicts the major components of the coordinated stern, omitting a depiction of the classified Stern Area System.

Figure 6: Notional Depiction of Major Components of the Columbia Class Coordinated Stern

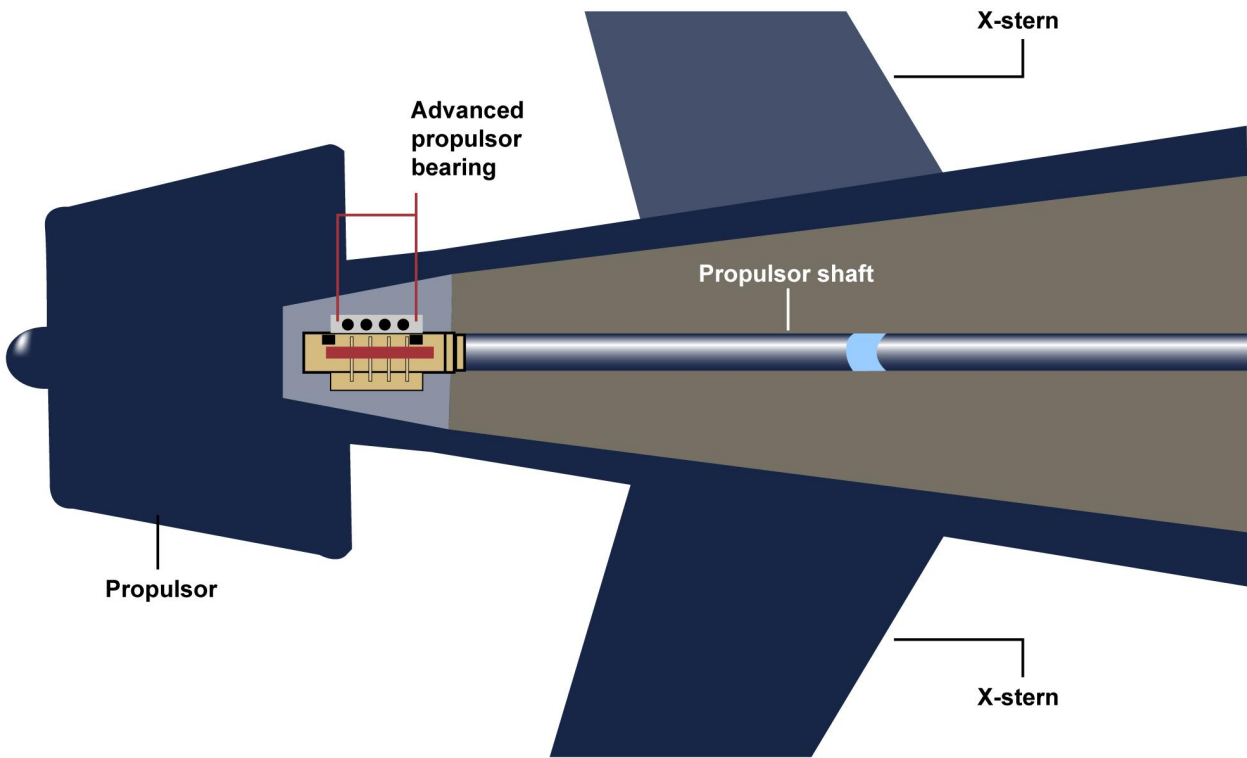

Source: GAO analysis of Navy documentation. | GAO-18-158

Acquisition Strategy for the Columbia Class

The Navy expects to require over \$267 billion (then-year dollars) in total life-cycle costs for the Columbia class program. Figure 7 shows the break-down of this amount between operations and support costs and acquisition costs, as well as the elements comprising the \$128 billion in acquisition costs.

Figure 7: Overview of Columbia Class Life-Cycle Cost Estimate (Then-Year Dollars, Millions)

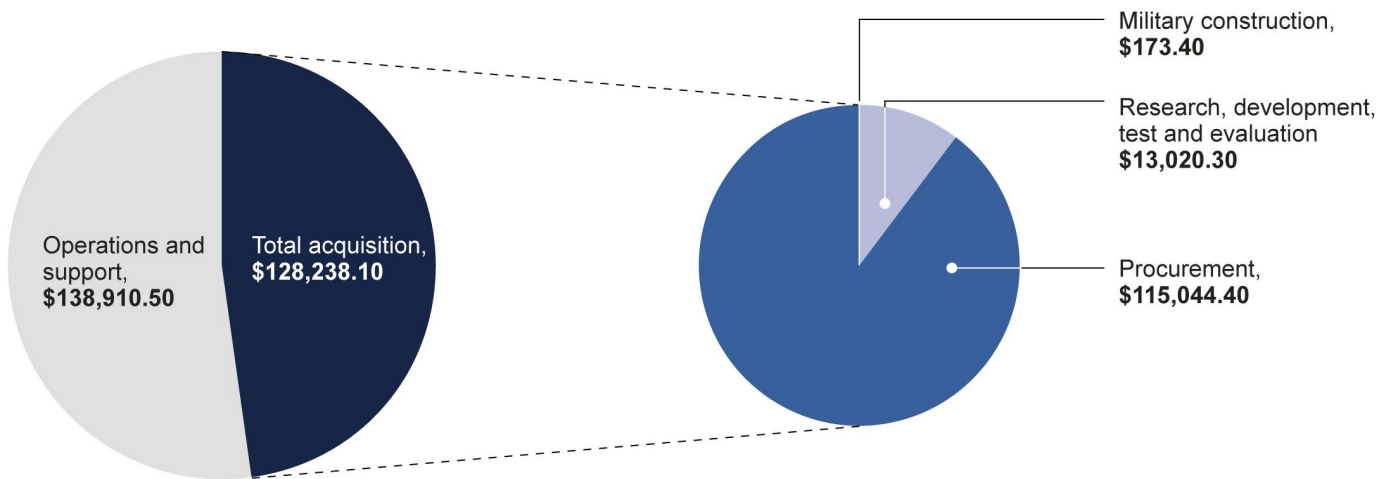

Source: GAO analysis of Navy documentation. | GAO-18-158

The approximately \$128 billion total acquisition cost includes funding the Navy expects it will need to research, develop, and build its Columbia class SSBN.

Due to their size and complexity, submarines require funding for design, long-lead materials (such as nuclear propulsion plant components), and construction over many years. To accomplish these activities, the Navy awards contracts over several phases of design and construction. Figure 8 outlines major acquisition plans for the Columbia class.

Figure 8: Acquisition Plans for the Columbia Class Submarine (in calendar year)

2008	2011	2012	2015	2017	2018	2020
<p>February Reactor plant and propulsion development contract award</p>	<p>January Milestone A, start of Columbia class technology development</p> <p>June Propulsion plant design contract awarded</p>	<p>December Research and Development contract award</p>	<p>October Strategic weapons system contracts awarded</p>	<p>January Milestone B, start of Columbia class system development</p> <p>September Design completion contract award</p>	<p>March Block I (Columbia 1 and 2) advanced procurement, long-lead time materials (LLTM), and continuous production contract award</p>	<p>February Budget request for lead ship authorization and funding</p> <p>May Production Readiness Review</p> <p>October Block I contract award; Columbia 1 construction start</p>
2023	2024	2026	2027	2028	2029	2030
<p>October Block II (Columbia 3, 4, and 5) LLTM, manufacturing, and construction contract award</p>	<p>March Columbia 2 starts construction</p>	<p>March Columbia 3 starts construction</p>	<p>October Columbia 1 contract delivery; developmental test and evaluation trials</p>	<p>September Columbia 1 missile qualification testing begins</p>	<p>April Columbia 1 post-shakedown availability</p>	<p>April Columbia 1 final missile qualification testing</p> <p>October Columbia 1 available for patrol</p>

Source: GAO analysis of Navy documentation and statements of Navy officials. | GAO-18-158

In 2014, Congress created a National Sea-based Deterrence Fund to provide DOD with greater discretion to fund the design, construction, and purchase of the Columbia class.⁹ Since then, Congress has provided the Navy with enhanced acquisition authorities to buy and construct submarines and certain key components early, in bulk, and continuously.

The Columbia class program entered the Technology Development phase of the defense acquisition process in January 2011. The schedule to acquire the Columbia class was shifted in 2011 when the Navy decided to delay the start of construction of the lead submarine by 2 years—from

⁹10 U.S.C. § 2218a: National Sea-Based Deterrence Fund.

2019 to 2021—due to budget constraints. The first patrol date for the lead ship was also shifted from fiscal year 2029 to fiscal year 2031. In January 2017, the Columbia class program achieved Milestone B—considered the official start of a DOD acquisition program—and moved into the Engineering and Manufacturing Development phase of the acquisition process. The program does not envision holding a Milestone C, which typically denotes a program’s approval to enter the production and deployment phase as shown in figure 9, but does plan to have an OSD-level review prior to authorizing the construction of the lead ship.

Figure 9: Acquisition Framework for Columbia Class Submarine Program

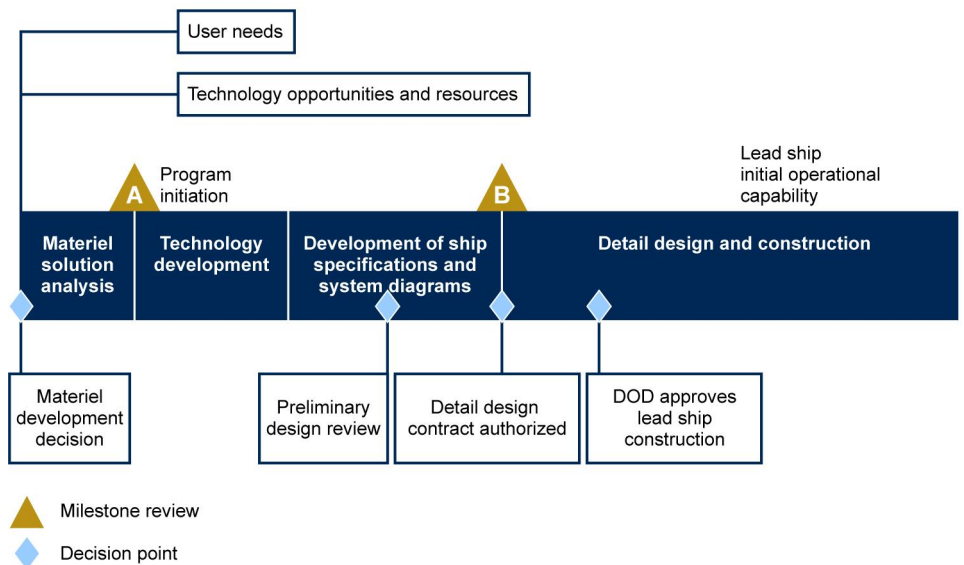

Source: GAO analysis of Department of Defense (DOD) data. | GAO-18-158

Shipbuilding programs have slightly different decision points than other DOD weapon systems, partly because of the timing of the Milestone B decision for ships.¹⁰ Milestone B for ship programs usually occurs after development of ship specifications and system diagrams is well under way.

As part of the Columbia class Milestone B decision, OSD approved a Low Rate Initial Production quantity of 12 submarines, the total quantity

¹⁰Milestone B for most weapon systems acquisitions occurs at the start of engineering and manufacturing development, several years before production of the system begins. The most common practice in ship programs is for milestone B to be aligned with the decision to authorize the start of detail design.

expected for the class. According to the Navy, the program awarded a \$5.1 billion detail design contract to Electric Boat in September 2017 for work including design completion, component and technology development, and prototyping efforts. Detail design is typically funded with Shipbuilding and Conversion, Navy funds (the Navy's procurement fund for buying ships) and represents a further refinement of the design of the ship and ultimately generation of work instructions needed by the shipyard in advance of lead ship construction. The program was granted approval to begin early detail design work in January 2017.¹¹

In shipbuilding, the design phase generally encompasses three activities: basic design, functional design, and detail design. These steps occur after the Navy sets the technical requirements for the ship. At a high level:

- **basic design** serves to outline the steel structure of the ship;
- **functional design** routes distributive systems—such as electrical or piping systems—throughout the ship; a three-dimensional (3D) computer-aided design model is often generated; and
- **detail design** completes the design work for even the lowest-level items, and ultimately furnishes the work instructions for the shipyard workers to use in constructing the ship. During this phase, all aspects of the ship are defined, and two-dimensional paper or 3D electronic drawings (also called work instructions) are generated.

For the Columbia class program, the Navy defines design in two phases: arrangements, which program officials describe as a combination of basic and functional design; and disclosures, which they describe as a combination of detail design and generation of work instructions. Figure 10 shows the phases of design for the program as compared with typical surface ship terminology.

¹¹The Columbia class program was granted approval—via a continuing resolution (CR) anomaly passed by the Congress—to use \$773 million in Shipbuilding and Conversion, Navy funds to begin detail design, even though this work had not yet been already authorized by the prior year spending bill. Regular annual appropriations acts that provide funding for the continued operation of federal agencies are considered by Congress annually. When action on regular appropriation bills is not completed before the beginning of the fiscal year, a continuing resolution may be enacted to provide funding for the affected agencies. There are a number of standard provisions enacted in most continuing resolutions that, when taken together, establish an expectation that agencies will continue to carry out the *status quo* during a continuing resolution, unless otherwise specifically stated.

Figure 10: Comparison of Design Phases for Columbia Class Submarine and Typical Surface Ships

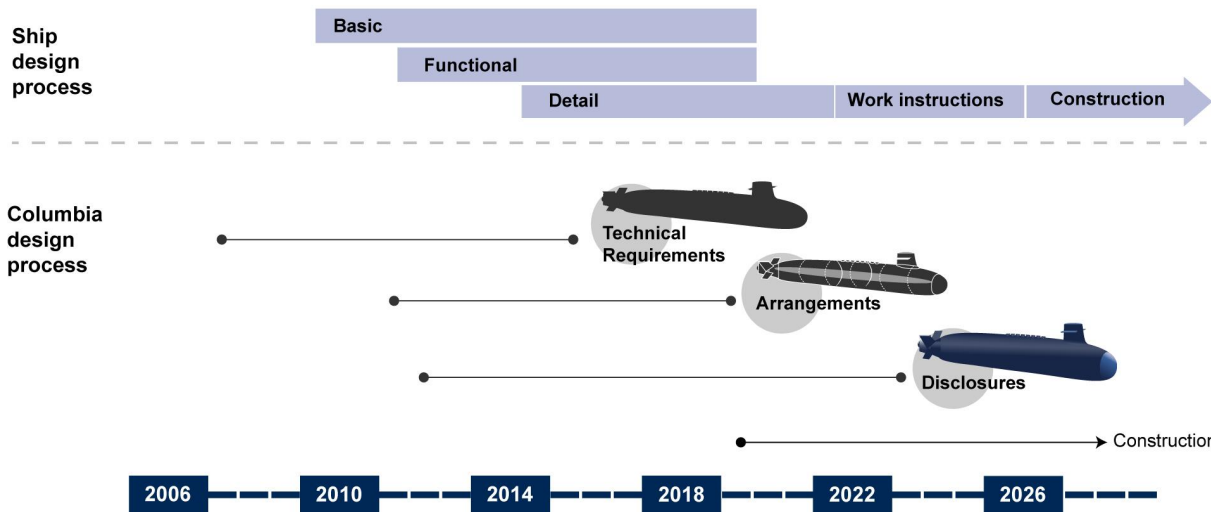

Source: GAO analysis of Navy documentation. | GAO-18-158

Two shipbuilders—General Dynamics Electric Boat and Huntington Ingalls Industries Newport News—are responsible for designing and building nuclear submarines.¹² For the Columbia class program, Electric Boat is the prime contractor for design and construction, with Newport News as a subcontractor. Similar to the Virginia class program, each shipyard will build modules of the submarine, but Electric Boat will be responsible for final delivery of the submarine to the Navy.

Technology Readiness Assessment

For more than a decade, our work on major acquisitions has shown that part of an effective management process is assessing how far a technology has matured and how it has been demonstrated, which indicates the technology’s readiness to be integrated into a system and the degree of program risk. DOD acquisition instruction requires that programs complete a technology readiness assessment (TRA) at Milestone B.¹³ A TRA is a systematic, evidence-based process that

¹²Electric Boat designed and built the entire class of Ohio SSBN. Electric Boat and Newport News share responsibility for the ongoing construction and delivery of 14 Virginia class attack submarines, with more under construction and planned.

¹³Department of Defense Instruction 5000.02; Operation of the Defense Acquisition System, Aug. 10, 2017.

evaluates the maturity of hardware and software technologies critical to the performance of a larger system or the fulfillment of the key objectives of an acquisition program. A reliable TRA illuminates concerns and serves as the basis for realistic discussions on how to mitigate potential risks as programs move from the early stages of technology development.

TRAs do not eliminate technology risk but, when done well, can illuminate concerns and serve as the basis for realistic discussions on how to mitigate potential risks as programs move from the early stages of technology development, where resource requirements are relatively modest, to system development and beyond, where resource requirements are often substantial. In addition, TRAs help legislators, government officials, and the public hold government program managers accountable for achieving their technology performance goals.

A main element of a TRA is the identification of critical technology elements (CTE) and assessment of the appropriate Technology Readiness Level (TRL), used to measure the readiness of technologies to be incorporated into a weapon or other type of system. TRLs range from 1 (least mature) to 9 (most mature), as shown in table 1.¹⁴

Table 1: Technology Readiness Levels (TRL)

TRL	TRL Description
TRL 1	Basic principles observed and reported
TRL 2	Technology concept and/or applications formulated
TRL 3	Analytical and experimental function and/or characteristic proof of concept
TRL 4	Component validation in a laboratory environment
TRL 5	Component validation in a relevant environment
TRL 6	System/subsystem model or prototype demonstration in a relevant environment
TRL 7	System prototype near or at the planned operational system demonstrated in an operational environment
TRL 8	Actual system completed and qualified through test and demonstration.
TRL 9	Actual system proven through successful mission operations.

Source: GAO. | GAO-18-158

¹⁴TRLs were pioneered by NASA and adopted by DOD to determine the readiness of technologies to be incorporated into a weapon or other type of system. A description of the TRLs is in appendix II.

^aThis table is based on Department of Defense 2011 Technology Readiness Assessment criteria and was reported in GAO, Technology Readiness Assessment Guide: Best Practices for Evaluating the Readiness of Technology for Use in Acquisition Programs and Projects, [GAO-16-410](#) (Washington, D.C., August 2016).

Current DOD guidance assigns the program manager responsibility for identifying CTEs. The program manager identifies possible technologies, then, in consultation with officials from the Assistant Secretary of Defense for Research and Engineering—ASD(R&E)—and with the program executive office and component acquisition executive approval, identifies the subject matter experts needed to perform the TRA.¹⁵ For the Columbia class TRA, the expert team was comprised of Navy program management and technical personnel. ASD(R&E) reviews the list of critical technologies provided by the program manager and recommends technologies to add or delete. Ultimately, the program submits the TRA report to ASD(R&E), who independently assesses the maturity of the technologies. The ASD(R&E) prepares a memorandum based on the assessment that is transmitted to the milestone decision authority, along with the TRA Report.

The TRA is also an element of the Milestone B approval process. Section 2366b, title 10, U.S. code states that a major defense acquisition program may not receive Milestone B approval until the milestone decision authority has, among other things, certified that the CTE has been demonstrated at a TRL 6.¹⁶ A program may request a waiver from OSD if the maturity provision cannot be met. The statute requires that:

- Every waiver determination must be submitted in writing to the congressional defense committees within 30 days after the waiver request by the program is authorized.
- The milestone decision authority reviews the program not less often than annually until the milestone decision authority determines that the program satisfies all certification and determination components.

In addition, in 2015 Congress required program acquisition strategies to include a comprehensive approach to risk management, including the consideration of techniques such as technology demonstrations and

¹⁵ASD(R&E) provides S&T leadership throughout the Department of Defense. For Navy programs, the Assistant Secretary of the Navy for Research, Development, and Acquisition serves as the Navy Acquisition Executive. The Assistant Secretary has authority, responsibility and accountability for all acquisition functions and programs.

¹⁶10 U.S.C. § 2366b(a)(2).

decision points for disciplined transition of planned technologies into programs or the selection of alternative technologies.¹⁷

Recognizing the importance of the TRA to risk management, in 2016, GAO developed a Technology Readiness Assessment Guide.¹⁸ This guide has two purposes: (1) to describe generally accepted best practices for conducting effective evaluations of technology developed for systems or acquisition programs; and (2) to provide program managers, technology developers, and governance bodies with the tools they need to more effectively mature technology, determine its readiness, and manage and mitigate risk. As noted above, we developed the guide by drawing heavily from DOD, DOE, and NASA best practices, terminology, examples, and credible resources, materials, and tools developed and applied by experts and organizations in order to capture the current thinking on technology readiness and maturity.¹⁹ In our guide, we identify criteria for a CTE, namely that it is a technology that is “new or novel, and needed for a system to meet its anticipated operational performance requirements; or that poses major cost, schedule, or performance risk during design or demonstration”.²⁰ According to our guide, re-used existing technologies can also become critical if they are being used in a different form, fit, or function—as is the case with the propulsor and coordinated stern.

Major Funding Commitments Planned, but Reporting on the Progress of Several Key Immature Technologies Is Not Required

Several key technical efforts remain immature as the Columbia class program moves into its design phase—a practice counter to best practices we have previously identified. These efforts include the integrated power system, nuclear reactor, propulsor/coordinated stern, stern area system, and common missile compartment. While the Navy made progress in some areas—such as prototyping efforts for the missile

¹⁷10 U.S.C. § 2431b.

¹⁸[GAO-16-410G](#).

¹⁹[GAO-16-410G](#).

²⁰[GAO-16-410G](#).

compartment and nuclear reactor—all of these systems continue to require development and testing to mature them to TRL 7, the point at which GAO’s technology readiness guide considers a technology mature. Any challenges in development could put the program at risk of costing more, taking longer to develop, or jeopardizing the program’s ability to meet its expected performance requirements. However, the Navy identified only two of the submarine’s technologies as “critical” in the program’s 2015 TRA, thereby underrepresenting the technology risk in the program. Underreporting technical risks can hinder Congress’ and other decision makers’ full understanding of the program’s progress. This is especially important because the Navy has already requested \$1.6 billion for advanced procurement and recently awarded the detail design contract. Moreover, there is no requirement that the Navy report to Congress on its progress in developing and testing the technologies until after the program completes its production readiness review in May 2020 after the Navy requests another \$8.7 billion in funding for the construction of the lead submarine.

Several Technologies Remain Immature as Detail Design Begins

Based on our assessment of the Navy’s documentation, the IPS, propulsor, and SAS are not yet at a TRL 7, and thus pose risk given their current level of demonstrated maturity and importance for meeting program cost, schedule, and performance requirements. Our previous work on shipbuilding best practices has found that technology maturity must be proven before a design can be considered stable, and production outcomes cannot be guaranteed until a stable design is demonstrated. In May 2009, we recommended that, before a contract is awarded for detail design, new ship critical technologies should be matured into actual system prototypes and successfully demonstrated in an operational environment (TRL 7). DOD concurred with this recommendation, but

Demonstrating Technology Maturity

Based on our work on best practices in weapon system acquisitions, we have previously recommended that programs fully mature technologies to TRL 7—versus TRL 6 as required by DOD—prior to passing Milestone B and entering the engineering and manufacturing development phase. TRL 7 represents a major step up from TRL 6, requiring demonstration of an actual system prototype in an operational environment such as in an aircraft, vehicle, or space. We have previously identified that demonstrating technologies in an operational environment provides a higher level of technology understanding and reduces risk prior to starting product development. DOD has historically disagreed with this recommended practice.

Source: GAO. | GAO-18-158.

added that modeling and simulation should be considered appropriate in some cases in lieu of actual prototype testing.²¹

While the Navy has made progress in reducing technical risks in many areas, such as starting construction of the first CMC, the program (according to the Navy) awarded a detail design contract in September 2017, with several key technologies not yet at a TRL 7.

The nuclear reactor, IPS, propulsor and coordinated stern, and SAS all have potentially significant effects on design and construction of the Columbia class because they encompass much of the design and physical structure of the submarine. Based on our analysis, we found that IPS, SAS, the propulsor and coordinated stern are not yet at a TRL 7, as depicted in figure 11. The nuclear reactor and CMC are further along in prototyping work but still require testing in an operational environment to achieve a TRL 7.

Figure 11: GAO Assessment of Maturity of Columbia Class Critical Technologies (as of November 2017)

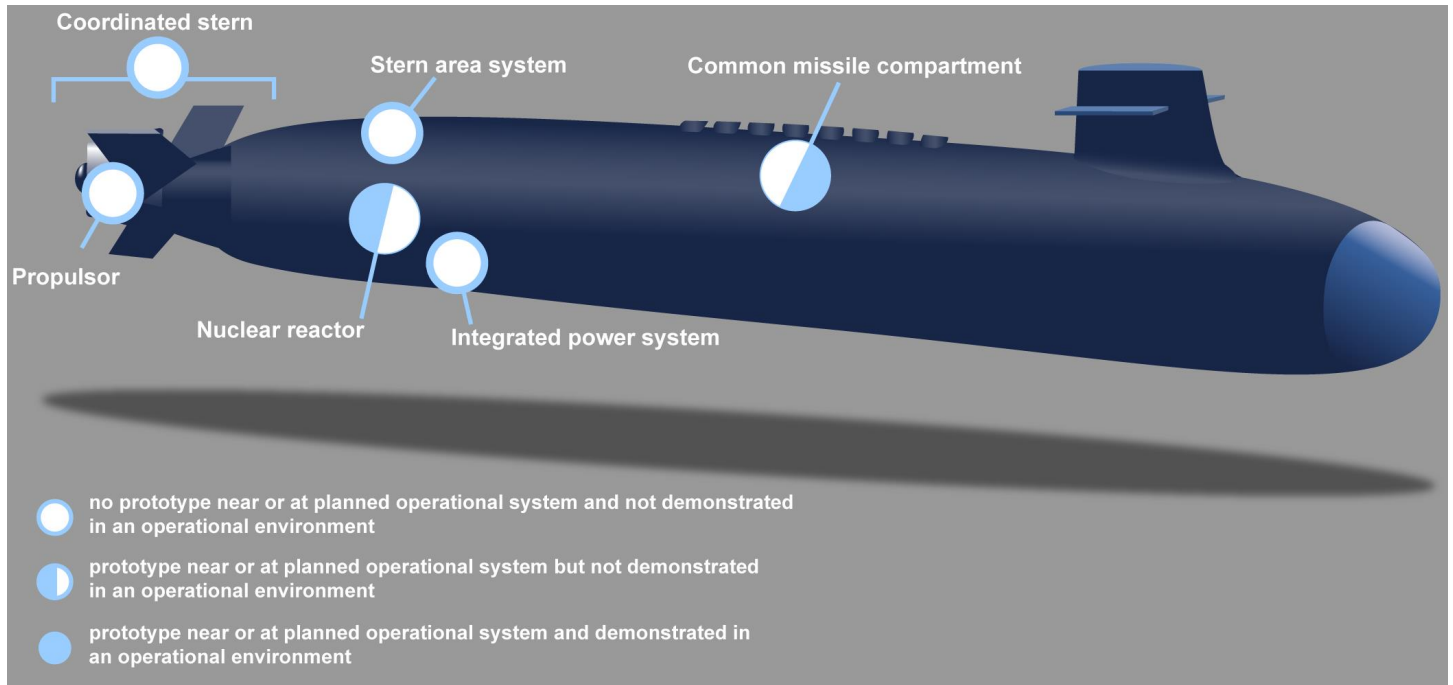

Source: GAO analysis of Navy documentation. | GAO-18-158

²¹GAO-09-322.

If any of these systems do not develop as planned, the Navy and the shipyards could be required to complete some redesign, or, if risks manifest later, they may force costly workarounds or construction rework. In addition, these systems also enable many performance attributes ranging from weapon launch to speed and maneuverability, so performance could be negatively affected. The status of these technologies is discussed in detail below.

Integrated Power System

According to officials from Naval Reactors, the permanent magnet motor-based electric drive system—a key component of IPS for the Columbia class—is at a TRL 6, below the TRL 7 recommended by our work on best practices. Naval Reactors has yet to develop an IPS prototype that is near or at the planned operational system configuration (integrated and full-size) and has been tested in an operational environment. The Navy has experimented with electric drive technology on submarines in the past with two now-decommissioned nuclear-powered attack submarines, but these submarines used different motor technology than what is planned for the Columbia class, and thus are not representative. The T-AKE 1 Lewis and Clark class of dry-cargo ammunition ships and DDG 1000 Zumwalt class destroyer are current U.S. Navy electric drive ships in operation, but these two systems are somewhat different than what is planned for the Columbia class and neither is powered by a nuclear reactor. The Navy is currently developing the IPS and producing a number of pre-production prototypes.

Naval Reactors officials told us that they are confident that the IPS will meet requirements based on 20 years of development and testing of the underlying permanent magnet motor technology. They also noted that this technology is proven based on testing of the smaller-scale prototype motor to validate the main propulsion motor design. However, Naval Reactors is still developing and producing the system's major components. Testing of a full-scale prototype under full power, which we would consider evidence that the technology is mature, is not scheduled to occur until fiscal years 2018-2020. In a land-based test facility, the Navy plans to integrate all the IPS systems in a ship-representative layout. Successful completion of this testing is an important step in mitigating risk. In contrast, the DDG 1000 program only tested its electric drive system at the land based test facility at one-half of the ship's power generation and electric propulsion system configuration, and as a result performance problems were not discovered until well after installation and when system testing on the ship was run at full power. Thus, the Navy's

planned full-scale prototype testing for Columbia class should prevent a similar experience, since it will test a full-sized and full-power system rather than a partial system.

Nuclear Reactor

According to officials from Naval Reactors, as a result of its statutory mandate, its programs follow a different development process than typical DOD programs and do not use documents typical of other Navy programs, such as an Integrated Master Schedule or a Test and Evaluation Master Plan. Instead, officials from Naval Reactors told us that they use a rigorous process to assess, manage and control technical risk during development and testing to manage its day-to-day technical efforts. Based on descriptions provided by Naval Reactors officials, the Navy has been operating a Columbia-like experimental reactor in a land-based environment for many years to demonstrate some Columbia class submarine systems. Naval Reactors officials said that this experience gives them confidence that the Columbia class reactor will be delivered to the shipyard on time and will meet all requirements.

Naval Reactors has design and development work remaining before it awards the contract for reactor core production in fiscal year 2019. Naval Reactors budget documentation shows that reactor design work is planned to be 65 percent complete in fiscal year 2018. While we recognize that it would not be realistic to expect Naval Reactors to test the reactor in a submarine to achieve a TRL 7, a completed design would still be required to produce a final configuration to demonstrate technology maturity.

Propulsor/Coordinated Stern

Neither the propulsor nor other related components of the coordinated stern have been demonstrated through testing in a near or planned operational system configuration, a key element for achieving TRL 7. Navy officials told us that the propulsor effort is based on prior experience with propulsors and that it will resemble the Virginia-class propulsor design. However, according to Navy documentation, the propulsor will be different in form, fit, and function than prior propulsors, and the final configuration has yet to be selected or tested. Specifically, the following components require additional design work and testing prior to demonstrating a representative prototype:

- **Propulsor:** The Navy is working with various partners to refine two different high-level propulsor designs. The program also faced a year delay in completing the first phase of design work, which subsequently delayed large-scale vehicle testing. Further, the Navy still has to complete large-scale prototype testing of different propulsor designs that are being evaluated for an eventual down-select to one vendor for production.
- **Propulsor shaft:** The system that connects the propulsion to the motors—which the Navy states is similar to shafting systems used on previous submarine classes but with different materials and size and weight—is still in concept and preliminary design phases. Main shaft design development and testing is being performed to select materials and inform design efforts.
- **Advanced propulsor bearing:** The Navy has yet to complete the preliminary design of the advanced propulsor bearing, with prototype test in a full scale configuration planned to begin in fiscal year 2019. Navy officials told us that they believe that the final design and material selections will exceed the reserved weight and size margins of the shafting or bearing system.
- **X-stern:** the final X-stern configuration has yet to be tested with a final design propulsor.

Our assessment of the propulsor and coordinated stern system design indicates that it is not yet mature enough to provide the basis for a prototype in final form, fit, and function—key elements of achieving TRL 7.

Stern Area System

The Navy identified the SAS as a TRL 4 at Milestone B. The preliminary design review for the SAS is planned for March 2018. This review establishes the baseline (hardware, software, human/support systems) and underlying architectures to ensure that the system has a reasonable expectation of satisfying requirements within the current budget and schedule. The critical design review—a technical review that ensures that a system can proceed into fabrication and demonstration and can meet stated performance requirements within cost, schedule, and risk—is not planned until March 2020.

A TRL 4 represents a relatively low level of maturity compared to the eventual system. At this low level of maturity, there are no assurances that the SAS will work as planned, which would likely result in the

Columbia class not meeting certain requirements or in cost and schedule increases. The Navy plans to hold a critical design review for SAS in fiscal year 2019. The Navy has identified existing fleet technologies as backups for two SAS components, but officials noted that if these are used the submarine will not meet current requirements. According to the program office, there is no backup technology for one other SAS component, and, if that element—currently a TRL 4—does not develop as planned, it will be omitted, meaning that the program will lack that capability.

Specific details of SAS are classified and cannot be included in this report.

Common Missile Compartment

The shipbuilders and the Navy have described CMC as complex to build. The Navy and the two shipyards—with consultation from the United Kingdom, which will also leverage the CMC design on its new SSBN—have conducted risk-reducing prototyping work and are building a representative CMC to demonstrate production processes. In fact, Columbia class representative missile tubes will be first installed on a United Kingdom submarine, scheduled for mid-2020. The Navy has plans for a robust land-based test procedure for both the missile tubes and the CMC as a system that will provide an operationally similar environment to a submarine; however, this testing has yet to start and will not conclude for several years.

The Navy Has Not Appropriately Identified Technologies as Critical, Which Underrepresents the Program's Technical Risk

While the Navy conducted the 2015 Columbia class TRA in accordance with a DOD-approved plan, it did not follow our identified best practices for identifying all critical technology elements (CTE), resulting in an underrepresentation of the technical risk facing the program. Specifically, the TRA only identified 2 CTEs: the SAS and a carbon dioxide removal system. CTEs are required to be at TRL 6 at Milestone B (the official start of a program). For the Columbia class program, OSD approved Milestone B in January 2017. The Navy received a waiver at Milestone B for the SAS because the system was still immature, as discussed above. The carbon dioxide removal system has matured since the TRA following

demonstration on an operational submarine, and no longer requires active risk mitigation efforts.

We compared the Navy’s 2015 Columbia class TRA to criteria documented in GAO’s TRA Guide and DOD’s own guidance. In doing so, we found that 4 additional key technical efforts—IPS, nuclear reactor, and propulsor/coordinated stern, and the CMC—meet the criteria for a CTE. Since the Navy did not identify these technologies in the TRA, it also did not assign them a TRL. Their exclusion is significant because the 2015 TRA represents a key independent review and technical risk assessment used by DOD to certify to Congress that the Columbia class program’s technologies had been demonstrated in a relevant environment (TRL 6) at Milestone B.²² Because not all of the CTEs were identified, DOD and Congress lack an important oversight tool for assessing technology maturity and evaluating program risk. Further, this certification is the only required reporting on technology development prior to the Navy requesting authorization for construction of the lead ship. Some of the concerns that we identified are discussed in detail below.

Conflicting Criteria for Identifying Critical Technologies

The team responsible for preparing the 2015 Columbia class TRA did not identify all appropriate CTEs because it used a more restrictive definition of a CTE than that recommended in our best practices guide and DOD’s 2011 TRA guide.²³ Table 2 compares the criteria in the three sources.

Table 2: Comparison of Criteria for Identifying Critical Technology Elements (CTE)

Criteria for Identifying CTEs	Criteria for Identifying CTEs	Criteria for Identifying CTEs
GAO Technology Readiness Assessment Guide Criteria ^a	Department of Defense (DOD) Technology Readiness Assessment Guide Criteria ^b	Navy Criteria for the Colombia Class Program ^c

²²ASDR&E also provides an independent technical assessment to OSD in support of the Milestone B review, but uses the Navy’s TRA as a key input to its decision-making process.

²³Our TRA best practices guide was published after the Navy’s TRA, but is valid for comparison because of the implications for the program going forward and because DOD officials provided input into developing our best practices.

Criteria for Identifying CTEs	Criteria for Identifying CTEs	Criteria for Identifying CTEs
GAO Technology Readiness Assessment Guide Criteria^a	Department of Defense (DOD) Technology Readiness Assessment Guide Criteria^b	Navy Criteria for the Columbia Class Program^c
The technology is new or novel, and needed for a system to meet its anticipated operational performance requirements; or poses major cost, schedule, or performance risk during design or demonstration.	The technology may pose major technological risk during development, particularly during the Engineering and Manufacturing Development phase of acquisition.	The technology is a technology development effort, ^d and is one on which the system depends to meet operational requirements or on which the program depends to meet cost and schedule objectives; and is new or novel and unproven; or is used or applied in a new or novel and unproven manner or environment.

Source: GAO analysis of DOD and Navy documents. | GAO-18-158

^aGAO, *Technology Readiness Assessment Guide: Best Practices for Evaluating the Readiness of Technology for Use in Acquisition Programs and Projects*, GAO-16-410G (Washington, D.C.: August 2016).

^bDepartment of Defense Technology Readiness Assessment (TRA) Guidance, April 2011; DOE, *Technology Readiness Assessment Guide* DOE G 413.3-4A, Oct. 22, 2015.

^c2015 Technology Readiness Assessment for the Columbia Class Submarine.

^dThe Navy did not define “technology development effort” in their 2015 Columbia class Technology Readiness Assessment.

As reflected in table 2, not only does the Navy’s TRA definition require a technology to meet a number of criteria to be considered a CTE, it also has to be considered a technology development effort. According to the Columbia class program office, the TRA team based this definition on a 2011 OSD AT&L memorandum issued contemporaneously with the 2011 TRA guidance that states: “TRAs should focus only on technology maturity, as opposed to engineering and integration risk.” However, our analysis of this memo found that it also directs programs to use DOD’s TRA guidance and CTE definition, which are broader and more consistent with our definition of a CTE. The 2015 Columbia class TRA does not further define what constitutes a technology development effort, with the Navy applying this as a criterion without defining what the criteria actually meant. Moreover, the TRA does not provide any definition or criteria for what it considers engineering and integration risk. We determined that the Navy under-identified program technical risks because the Navy’s criteria were more restrictive than GAO’s CTE definition.

Several Critical Technologies Not Identified

We further assessed the specific technologies in the Columbia class program against our technology readiness criteria for a CTE, as shown in table 3.

Table 3: Assessment of Columbia Class Key Technology Efforts Using GAO’s Critical Technology Element (CTE) Criteria

n/a	GAO Critical Technology Criteria ^a and GAO Assessment	GAO Critical Technology Criteria ^a and GAO Assessment	n/a
Technology	GAO criteria 1: Is it new or novel and needed to meet performance requirements?	GAO criteria 2: Does it pose major cost, schedule, or performance risk?	Did the Navy identify it as a critical technology?
Integrated Power System (IPS)	<p>Yes.</p> <p>The Navy has limited past experience with ships or submarines exclusively powered by electric drive. The system being developed for the Columbia class will be different from the electric drive systems equipped on U.S. Navy ship classes and on two legacy submarines. It is critical to meeting performance requirements.</p>	<p>Yes.</p> <p>Delays could have significant impacts to production since its systems traverse much of the design, resulting in potentially significant cost growth due to schedule slips and work arounds. If it does not work as intended, the program would be likely unable to meet performance requirements.</p>	<p>No.</p> <p>The Navy’s Technology Readiness Assessment (TRA) team determined that IPS impacted operational requirements and was used in a new or novel and unproven manner or used in a new or novel and unproven environment, but was deemed not to be a technology development effort so it was not identified as a CTE.</p>
Nuclear Reactor	<p>Yes.</p> <p>A new design and technical features enable it to function longer than any other submarine. It is also critical to reducing maintenance periods that enable the Navy to reduce the fleet by 2 submarines compared to the existing fleet of 14.^b</p>	<p>Yes.</p> <p>If the reactor cannot provide life-of-the-ship capability, the Navy will need to procure more submarines to compensate for the additional extended maintenance period, adding billions of dollars to the program. If it does not work as intended, the program would likely be unable to meet performance requirements.</p>	<p>No.</p> <p>The Navy’s 2015 Columbia class TRA does not include analysis of the nuclear reactor. The TRA team only assessed technologies under the cognizance of the Columbia class program office; the nuclear reactor is under the cognizance of Naval Reactors.</p>

n/a	GAO Critical Technology Criteria ^a and GAO Assessment	GAO Critical Technology Criteria ^a and GAO Assessment	n/a
Technology	GAO criteria 1: Is it new or novel and needed to meet performance requirements?	GAO criteria 2: Does it pose major cost, schedule, or performance risk?	Did the Navy identify it as a critical technology?
Propulsor/ Coordinated Stern	<p>Yes.</p> <p>According to the Navy, the propulsor; X-stern configuration; and shafting system are all new designs, representing the next generation from current components with different performance requirements.</p> <p>The propulsor will be an advanced design that is required to be different in size and weight and operate at a different number of rotations per minute than prior propulsors to account primarily for the larger submarine. It will also be required to perform to different survivability and maintenance requirements than prior submarines.</p> <p>Program will use a non-traditional type of stern that is different from prior configurations to meet specific requirements.</p> <p>The shafting system will be redesigned from prior submarines (e.g., different diameter shaft and bearings) to support the different propulsor.</p> <p>Other program office documentation identified propulsor performance and coordinated stern as technology development efforts.</p>	<p>Yes.</p> <p>Late delivery of the propulsor or other elements of the coordinated stern could lead to cost growth and compromise the submarine delivery schedule.</p> <p>If the propulsor and related components do not work as required, the Navy may have to accept reduced performance attributes.</p> <p>The propulsor shaft needs to achieve a 12-year service life and meet a requirement to complete shaft replacement within a four month dry dock period. Achieving this change-out time helps enable the Navy to procure 12 submarines instead of 14.</p>	<p>No.</p> <p>The Navy's TRA team determined that the propulsor/coordinated stern impacted operational requirements and was used/applied in a new or novel manner but not used/ applied in an unproven or in a new or novel and unproven environment.</p> <p>This system was not deemed a technology development effort.</p>
Stern Area System	<p>Yes.</p> <p>Details classified.</p>	<p>Yes.</p> <p>Not achieving required capabilities could result in the Columbia class not meeting certain requirements. Details classified.</p>	<p>Yes.</p> <p>The Navy's TRA team determined that the Stern Area System was a critical technology.</p>

n/a	GAO Critical Technology Criteria ^a and GAO Assessment	GAO Critical Technology Criteria ^a and GAO Assessment	n/a
Technology	GAO criteria 1: Is it new or novel and needed to meet performance requirements?	GAO criteria 2: Does it pose major cost, schedule, or performance risk?	Did the Navy identify it as a critical technology?
Common Missile Compartment (CMC)	<p>No.</p> <p>Not new or novel, but critical to meeting performance requirements. According to Navy officials, CMC is based on prior technology fielded Ohio class submarines, albeit with some repackaging and updated technology.</p> <p>Since CMC includes the hardware and software that launches the ballistic missiles from the submarine, this component is critical to meeting performance requirements.</p>	<p>Yes.</p> <p>Not delivering a working CMC would compromise performance requirements. CMC is integral to the hull of the submarine, so any delays could challenge construction efficiencies and thus lead to cost and schedule growth.</p> <p>Further, the CMC carries the strategic weapon system that is the primary mission of a ballistic missile submarine. The Navy faces the challenge of restarting production of missile tubes and parts from a dormant industrial base (the last submarine ballistic missile tubes were built in the early 1990's). The CMC will also require new materials.</p>	<p>No.</p> <p>The Navy's TRA team did not evaluate the CMC.</p>

Source: GAO analysis of Navy documentation. | GAO-18-158

^aGAO, *Technology Readiness Assessment Guide: Best Practices for Evaluating the Readiness of Technology for Use in Acquisition Programs and Projects*, GAO-16-410G (Washington, D.C.: August 2016).

^bOhio class submarines have a mid-life maintenance period where the nuclear reactor is refueled that lasts almost 3 years; the new life-of-core reactor for the Columbia class submarine is planned to eliminate a year from this maintenance period.

As shown in table 3, by applying the additional “technology development effort” criteria in the 2015 Columbia class TRA, the TRA team eliminated several systems from CTE consideration without criteria or a definition of what constitutes a technology development effort. Some of these systems were previously identified as CTEs in other recent Navy documentation. The TRA team did not identify the nuclear reactor as a CTE because this system is under the cognizance of Naval Reactors and not the Columbia class program office. Officials from Naval Reactors told us that they do not conduct TRAs, but rather follow a different and more iterative process to manage their technology development efforts.

While the Navy did not identify all of the program’s CTEs as compared with the TRA criteria in our guide, it is tracking these efforts to manage technology risks. For example, 3 of the 4 CTEs we identified are also identified in Navy documents as “key technical efforts” with active risk

mitigation plans.²⁴ We will continue to track the progress of these efforts in our future work.

Required Report to Congress on Technology Efforts Will Not Occur Until after Lead Ship Authorization

As the Columbia class program moves into its detail design and construction phase, it will be more than 2 years before the next requirement for a formal DOD report to Congress on the progress of the technology efforts. This will occur at some point after the program's Production Readiness Review is completed in May 2020.²⁵ In the meantime, the Navy plans to request another \$8.7 billion (in addition to the \$1.6 billion already requested) for lead ship construction. If a typical budget schedule is followed, this request will come before Congress in February 2020. The Navy plans to begin construction of the lead submarine starting in fiscal year 2020. Congress will be asked to approve lead ship construction absent key information on the maturity of the critical technologies that, at present, are not up to the maturity levels that would provide assurance they will work as intended. Without additional updates on the progress of technology maturity between now and 2020, we believe Congress will not have information it needs to evaluate technical risk in advance of the Navy's requests for considerable increases in program funding. As previously discussed, there is currently no DOD requirement to submit such reports to congressional oversight committees.

²⁴The Navy did not include the nuclear reactor as a key technical effort.

²⁵The National Defense Authorization Act for Fiscal Year 2008 requires programs to submit a report to the congressional defense committees on the results of any production readiness review and certify to the congressional defense committees that the review supports the start of construction, and includes (among other things) an assessment including of the maturity of developmental command and control systems, weapon and sensor systems, and hull, mechanical and electrical systems. Pub. L. No. 110-181, § 124 (2008).

The Navy Plans to Leverage Completed Design to Mitigate Aggressive Schedule, but Ongoing Technology Development Likely to Undermine This Goal

The Navy is prioritizing design completion before starting construction, which is a good practice that is in accordance with our work on best practices because it helps reduce cost and schedule challenges in construction. However, since some of the key technologies are not fully matured, detail design work is proceeding with notional or placeholder data representing these key systems. As a result, the design will likely remain immature once construction starts in fiscal year 2021. We have previously reported that concurrency of technology development and design increases the risk of design rework—or having to make modifications to design drawings to accommodate any changes needed as a result of technologies changing size, shape, or weight as they mature—and potentially can result in negative cost and schedule impacts.²⁶ Further, the Navy faces an aggressive production schedule in order to deliver the lead submarine by fiscal year 2031, which will be required to prevent a gap in U.S. nuclear deterrent capabilities. According to our analysis of previous submarine program schedules, the Columbia class program’s schedule is aggressive in its expected short duration to build the lead submarine. The program office intends to mitigate this schedule challenge, in part, by starting construction of portions of the submarine earlier than initially planned. If this early construction occurs and the Navy does not alter design plans, construction of some parts of the lead submarine could outpace a finalized design for developing other components, which increases the risk of rework during construction and could further delay completion.

Consistent with Best Practices, Program Has Prioritized Design Completion, but Immature Technologies May Compromise Design Maturity

The Columbia class program is prioritizing a high level of design completion prior to the start of construction of the lead submarine of the

²⁶[GAO-09-322](#).

class. The program plans to complete 100 percent of design arrangements and 83 percent of design disclosures prior to the start of construction of the lead submarine. In our 2009 report on best practices in shipbuilding, we identified design maturity as important step in reducing cost and schedule risk. As such, we recommended that the design be stabilized through completion of basic and functional design and 3D product modeling prior to the start of construction for a new ship. Because, as mentioned previously, the Navy defined design arrangements on the Columbia class program as being equivalent to basic and functional design, having 100 percent of the arrangements completed prior to the start of Columbia class construction would meet the intent of our prior recommendation.

Further, our analysis found that the Columbia class program's planned level of design completion prior to starting construction is much higher than most recent Navy shipbuilding programs. For example, the Virginia class attack submarine program started construction with only 43 percent of the design complete compared with a planned 83 percent completion for the Columbia class. The Columbia class program also plans to have a 52 week buffer between the completion of design for an area of the submarine and the start of construction on that area, which is intended to allow time to address any challenges that may arise and thus minimize schedule delays. Additionally, the Navy plans to have all components fully developed 8 months before they are required in the shipyard, which will provide some additional schedule buffer to address challenges before the components are actually needed for construction.

To facilitate design completion, the Navy made a commitment at the start of the program to set realistic and reasonable requirements and to keep those requirements stable throughout the program. This approach is also in keeping with our previously identified best practices, which highlight the importance of demonstrating balance among program requirements, technology demands, and cost considerations. The Columbia class program has not had any significant requirements changes since DOD's Joint Requirements Oversight Council validated the Capability Development Document in 2015. Setting realistic and reasonable requirements also permitted the Navy and shipyards to reuse some design elements for components of the submarine that are similar in design and function to the Virginia class instead of requiring new design work. Similarly, the program has worked to keep stable ship specifications to minimize design disruptions.

The technical specifications for the ship have been set since 2014, and the program manager maintains personal visibility and accountability over any proposed deviations or changes to the specifications. According to the program manager, to date there have been minimal changes made to the technical baseline. These steps help to minimize design rework that can be caused by changing requirements, as was seen on the Littoral Combat Ship program, and that can lead to cost increases or scheduled delays.²⁷ The program has also conducted some prototyping efforts—including building representative portions of the submarine to demonstrate that its design tool can send the correct information to the shop floor to build the ship—and has plans for more.

However, based on our analysis of the program’s current technology development plan and status, it is unlikely that the Navy’s planned 83 percent of design disclosures will be finalized at the time construction begins for the lead ship in 2021. Similar to many shipbuilding programs, the Columbia class program plans to continue to mature technologies into their final form while detail design is underway. As we have previously reported, to offset this risk, shipbuilding programs, including the Columbia class, often include design “reservations” for space, weight, power, cooling, and other key attributes to reserve a footprint for components. As contractors or government employees develop and refine technologies or systems, they provide vendor furnished information (VFI) or government furnished information (GFI) to the shipyards to update the design. Completion of the detail design of the submarine—and subsequent achievement of design stability to support a properly sequenced construction phase—requires shipbuilders to have final information on the form and fit of each system that will be installed on the ship, including the system’s weight and its demand for power, cooling, and other supporting elements.²⁸

As development proceeds on a new technology, initial assumptions about size, shape, weight, and power and cooling requirements can change,

²⁷ [GAO-09-322](#). The Navy sought to concurrently design and construct two lead ships in the Littoral Combat Ship (LCS) program in an effort to rapidly meet pressing mission needs. Implementation of a new design standard required program officials to redesign major elements of each LCS design to meet enhanced survivability requirements, even after construction had begun on the first ship. While these changes improved the robustness of the LCS designs, they contributed to out-of-sequence work and rework on the lead ships. See [GAO-13-530](#).

²⁸ [GAO-09-322](#).

potentially significantly. These changes in VFI or GFI—if not resolved early in the design phase—can introduce considerable volatility to the design process for a lead ship. As such, in our May 2009 report, we recommended that, to attain the level of knowledge needed to retire design risk and reduce construction disruptions, complete—versus notional—VFI or GFI must be incorporated for the design to be truly stable.²⁹ DOD concurred with this recommendation. We have previously reported that other Navy programs have run into difficulties, including out-of-sequence or more costly construction work, when space, weight, power, and cooling reservations are based on immature or ill-defined technologies or components that have changed in size, weight, or other attributes when they are finalized. Ramifications from such changes can ripple through much of the ship design. For example, we reported in 2009 that during construction of the Seawolf-class attack submarine, the AN/BSY-2 combat system did not fit into the space and weight reservations that the Navy had allocated within the submarine's design. As a result, a portion of the submarine had to be redesigned at additional cost.³⁰

However, the Navy has entered the detail design phase for the Columbia class with incomplete technical data on several key components that are either significant in size relative to the submarine or spread throughout a number of spaces of the submarine. These components include IPS, the nuclear reactor, the propulsor and coordinated stern, and SAS. This situation is problematic because even if the Columbia class design is 83 percent complete, if it contains many reservations for systems that are not fully developed the design will continue to be immature and subject to change. Thus, the 83 percent completion metric may be somewhat meaningless since elements of the design are uncertain and could change because of the incomplete technology development efforts.

As shown in figure 12, the Columbia class program has entered the detail design phase with a number of technologies still in development or design finalization, which means that the VFI/GFI for these systems are not yet final. This figure also depicts our recommended knowledge points for shipbuilding programs, which align with contract award for detail design and the start of lead ship construction. The concurrency depicted

²⁹[GAO-09-322](#).

³⁰[GAO-09-322](#).

between phases could be further exacerbated if the Navy pursues plans to start construction of some components early.

Figure 12: Concurrency of Navy Technology Development and Detail Design and Lead Ship Construction

Best practice



Columbia class

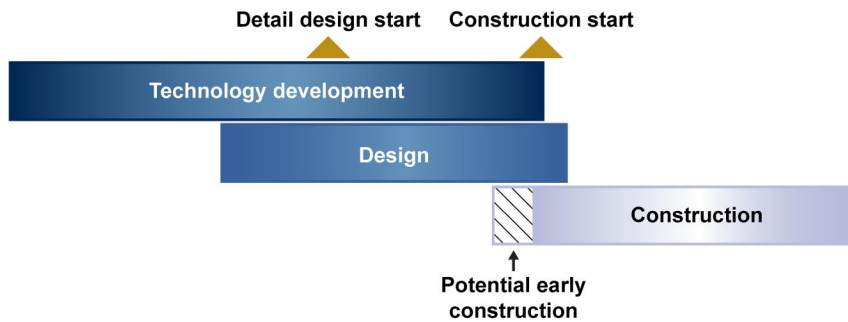

Source: GAO analysis of Navy documentation. | GAO-18-158

As is shown in figure 12, the Navy plans to continue technology development while executing detail design; this concurrency may potentially extend through construction if the Navy pursues its plans for early construction. For example, the Navy and the shipyards are currently designing the stern of the submarine—with 95 percent of stern arrangements planned to be complete by December 2017—but the final configuration of the propulsor has yet to be determined. As currently planned, the Navy will not complete prototype testing until the third quarter of fiscal year 2020, and development and design of the SAS is planned to continue until the end of fiscal year 2021—almost a year after the start of lead ship construction. The Navy believes it is managing this stern risk by controlling the interfaces through an Interface Control Document that identifies set design constraints. According to Navy officials, all aspects of the propulsor design that could impact the overall ship design such as size, weight, and arrangements of major sub-assemblies of the propulsor are already finalized, and that the systems are currently tracking to the reservation allowances. However, until a final representative prototype is tested as a system, the possibility of design

changes and broader design impacts remains. Although the Navy plans to have arrangements for the stern 100 percent complete at construction start, the VFI or GFI for these important systems will not be finalized until later after these systems finish development.

Additionally, the electric drive of IPS has already experienced manufacturing problems that could compromise its ability to meet its schedule if further challenges arise. According to Naval Reactors officials, a manufacturing defect was identified in February 2017 that affected the assembly of the first production-representative propulsion motor intended for installation in the land-based test facility to prove out the integration of all the electric drive components. The officials explained that the vendor responsible for the motor is in the process of repairing the defect—a process that will take up to 9 months to complete. As a result, Naval Reactors is now executing a schedule recovery plan to regain some schedule margin. Part of this plan involves using a smaller scale prototype motor in initial land-based test facility testing to prove out system integration. This plan means that initial full-scale system testing will be conducted with a different motor, albeit one with the same electromagnetic properties. Further, this delay will leave less margin to account for any unexpected challenges encountered in developmental testing.

Aggressive Construction Schedule for Lead Submarine Unprecedented

The Columbia class program has an aggressive schedule to deliver the lead submarine in time to begin patrols in fiscal year 2031. The Navy plans for 84 months, or 7 years, to build the lead submarine. While imperatives associated with our nation's nuclear deterrent are driving this planned schedule, our analysis shows that it is significantly shorter than what the Navy has achieved on any recent lead submarine construction effort—including during high levels of Cold War submarine production. The Navy expects that the Columbia class will be built in the same timeframe as was planned for the lead Virginia class submarine—a submarine that is one and a half times smaller and has less estimated construction man hours than the Columbia class. Figure 13 shows the estimated and actual timeframes for constructing prior lead submarines as compared with the 84 month estimate for the Columbia class lead submarine.

Figure 13: Estimated and Actual Schedules for U.S. Navy Lead Submarines (months)

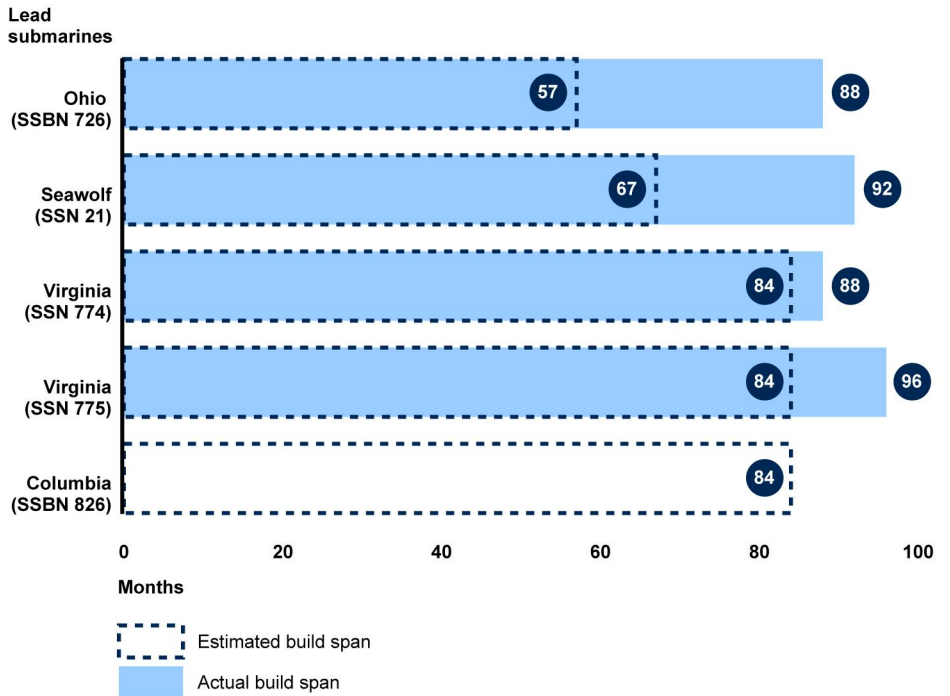

Source: GAO analysis of Navy data. | GAO-18-158

Further, there are industrial base implications to this aggressive schedule. The Navy and the two shipyards will be trying to attain this level of unprecedented schedule performance with the lead submarine while the shipbuilders are also starting work on the first few Virginia class submarines built in a new Block V configuration.³¹ Virginia class program officials told us that the ramp-up to building two attack submarines per year has resulted in recent cost and schedule growth at the shipyards. The addition of Block V and Columbia-class will likely create additional schedule pressures with the increase in workload required to build those submarines compared with non-Block V version submarines.

In an effort to mitigate the risks associated with its aggressive delivery schedule, the Navy is planning to start construction of a number of parts of the structure of the lead submarine years earlier than the date of lead

³¹Block V represents an improvement in capabilities for the Virginia class program and will require a significant increase in labor hours needed to build the submarine, including the insertion of a new 80 foot long Virginia Payload Module with Tomahawk missile tubes.

ship authorization in fiscal year 2021. This plan, called advanced construction, would use expanded acquisition authorities provided by Congress in the National Sea-Based Deterrence Fund.³² The Navy and its shipbuilders intend to start construction as early as 2019 on numerous areas of the submarine’s structure. Specifically, the Navy and shipyards plan to start building the stern, bow and missile command and control module as early as 6 months before fiscal year 2021, citing the disruptive effects of delays to these three “super-modules” that are also critical to ensuring an on-time delivery. These super-modules also comprise vital areas of the submarine, including the CMC, IPS and the coordinated stern. The shipyards have proposed moving 500,000-600,000 labor hours of construction work to before ship authorization. Figure 14 shows the super-modules of the submarine that the Navy plans to start early.

Figure 14: Plans for Early Start of Lead Columbia Construction Focus on Critical Areas

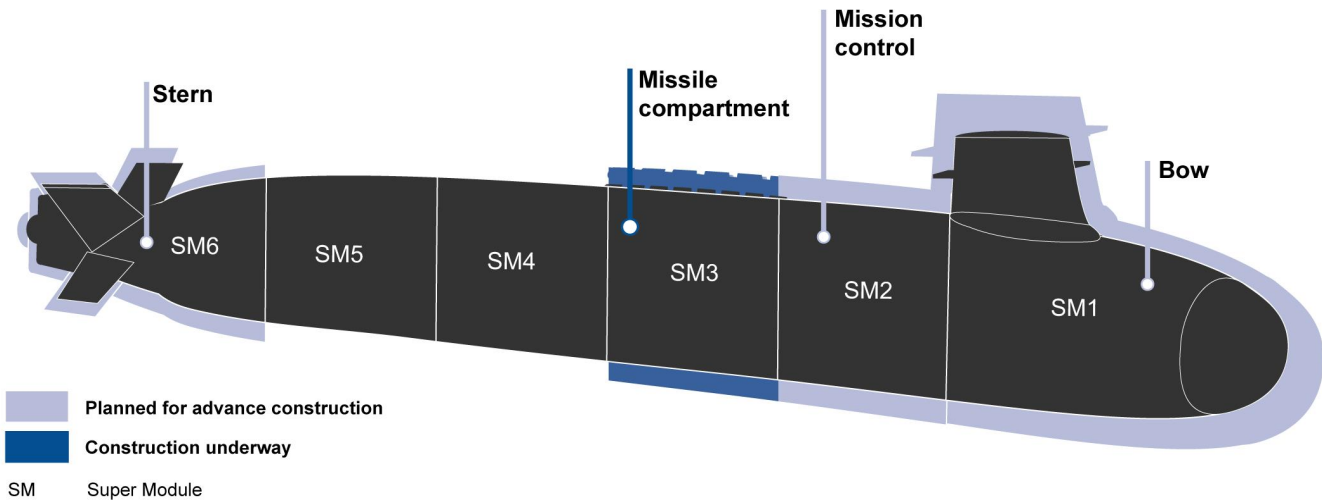

Source: GAO analysis of Navy documentation. | GAO-18-158

However, the Navy has yet to finalize or fund the approach for this type of early work. Starting construction early for the lead and follow submarines provides schedule relief to the Navy and shipbuilders, but these plans may further exacerbate the existing overlap of technology development and design and construction, which was discussed above. Moving construction earlier could challenge the Navy’s goal to have all components developed 7 months before they are required in the shipyard. Further, the shipbuilders acknowledged that early construction

³²10 U.S.C. § 2218a. National Sea-Based Deterrence Fund.

plans will result in increased overlap between various stages of design activities in certain areas, including the bow and stern. If Congress funds the Navy's plans to fund advanced construction work, this incomplete VFI/GFI situation will likely be worsened and could disrupt the optimal build strategy.

We have previously reported that programs starting construction of the lead ship of a class without a mature, stable design has been a major source of cost growth and schedule delays in Navy programs. We have also reported that when a schedule is set that cannot accommodate program scope, delivering an initial capability is often delayed and higher costs are incurred because problems typically occur that cannot be resolved within compressed, optimistic schedules. The Navy's Columbia class plans put the program at risk of cost and schedule growth. However, its options for reducing concurrency are, at this point, limited due to the schedule imperatives driven by the lead ship patrol deadline.

Columbia Class Is Not Funded Adequately to Address Program Risks

Our analysis determined that it is more likely than not that the Columbia class program will exceed the Navy's \$128 billion (then-year dollars) estimate of total acquisition cost to which the program will be funded. Specifically, the program's 2017 Milestone B cost estimates are optimistic because they do not account for a sufficient amount of program risk due to ongoing technology development, as well as the likely costs to design and construct the submarines. In addition, the Navy has budgeted the program to a confidence level for the program that is lower than what experts recommend, with a particularly optimistic estimate for the lead ship.³³ While there may be situations when this would be appropriate, this is not the case for the Columbia class program due to the technical and design risks that we identified above. As a result, program costs will more likely than not exceed requested funding, particularly for lead ship construction. Due to the significant level of funding required for this program, even a small percentage of cost growth could have far-reaching consequences on the Navy's long-range plans to fund construction of its future fleet. For this review we conducted an initial analysis of the Navy's

³³GAO, *Cost Estimating and Assessment Guide: Best Practices for Developing and Managing Capital Program Costs*, [GAO-09-3SP](#) (Washington D.C.: March 2009).

cost estimate but did not assess if it was conducted in accordance with all of the best practices identified in our cost estimating guide. We plan to more fully assess the Navy's life-cycle cost estimate for the entire Columbia class, including the program's risk analyses, in future work.

Confidence Levels and the Navy's Estimate

From early on, the Navy recognized the need to control costs for the Columbia class. In fact, the program's cost estimates have decreased significantly since the program's inception due to Navy decisions early in the program to trade off some capabilities and the incorporation of updated actual cost data from the continued procurement of Virginia class submarines. At Milestone B, OSD determined that Columbia class procurement costs had fallen almost 40 percent since the program's original estimate.³⁴ However, while the Navy did conduct a risk analysis for its recent Columbia class cost estimates, the confidence level of the Navy's estimate at Milestone B for acquisition of the entire class is 45 percent. This means that it is more likely than not that actual costs to research, develop, and buy the submarines will exceed the Navy's \$128 billion estimate.

Confidence Levels

A confidence level is stated as a percentage depicting the probability that the program's cost will actually be at some value or lower, calculated after conducting a risk analysis to identify and quantify program risks and determine the effects of these risks on its point estimates.

Source: GAO. | GAO-18-158.

This situation is particularly apparent at this point with regard to costs to design the class and build the lead submarine. Any difficulties in ongoing technology development efforts would likely worsen the picture. At Milestone B, the Navy's point estimate to develop the technologies, design the class, and build the lead Columbia was at a 43 percent confidence level.

Experts agree that programs should be budgeted to at least the 50 percent confidence level, but budgeting to a higher level (e.g., 70 to 80 percent, or the mean) is a common practice to cover increased costs resulting from unexpected design complexity and technology uncertainty, among other things.³⁵ Navy cost guidance recommends using the "risk adjusted mean" for the cost for the program, which usually lies between 50 and 60 percent. If the Navy budgeted to an estimate at a higher confidence level like the risk adjusted mean, its Milestone B point

³⁴Decisions earlier in the program that traded off capabilities—namely, reducing the planned buy from 14 to 12 submarines and the number of missile tubes from 20 to 16—significantly reduced costs prior to the program's 2011 Milestone A.

³⁵[GAO-09-3SP](#).

estimates—meaning the selected estimate of cost—would be higher, reducing the probability of overruns occurring. According to Navy cost analysts, the program’s total acquisition cost, which the Navy estimated at Milestone B at \$128 billion (then-year dollars), would exceed \$131 billion (then-year dollars) at 50 percent confidence, which is the bottom range of the risk adjusted mean confidence level.

Cost Growth Potential Based on the Navy’s Estimate

Even if the Navy budgeted to the 90 percent—a “worst-case” scenario where significant programmatic challenges are realized and the probability of cost overruns is low—confidence level, Columbia class lead ship costs would not be dissimilar to cost outcomes on other lead ship programs. We have observed in prior work that cost growth for recent lead ships across the Navy’s shipbuilding portfolio is 28 percent on average.³⁶ For example, the Navy’s lead Virginia class submarines (SSN 774 and SSN 775)—the most similar class to Columbia in terms of technology and component development as well as aspects of its design and build plans—experienced 15 and 24 percent budget growth respectively, with average cost growth of 28 percent for the three most recent lead submarines (see figure 15).

³⁶See, for example: [GAO-05-183](#); [GAO-09-322](#); [GAO-16-84T](#).

Figure 15: Cost Growth in Program Budgets for the Three Lead Navy Submarines Authorized to Start Construction since 1989

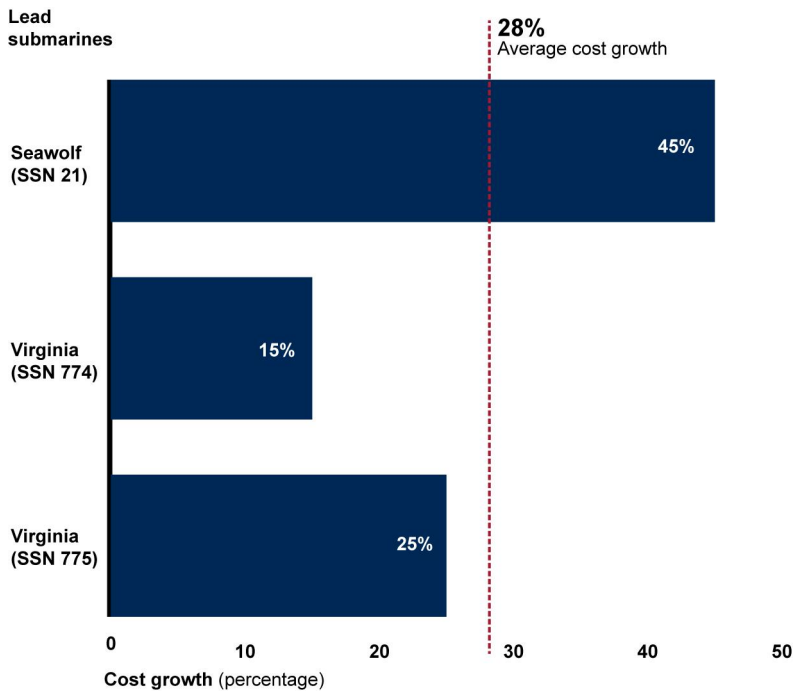

Source: GAO analysis based on Navy budget documentation. | GAO-18-158

Note: SSN 775, the second Virginia-class submarine, was constructed in a different shipyard than the first submarine in the class with the same design—SSN 774.

The 28 percent cost growth we have observed is slightly more than the 22 percent cost increase between the Navy’s point estimate and the 90 percent confidence level, meaning that even if the Navy budgeted the program to the 90 percent confidence level there would still be historical shipbuilding precedence for further cost growth. In particular, if costs to build the lead Columbia class submarine grow similar to the lead Seawolf and Virginia class submarines, the cost to construct the submarine would exceed the Navy’s Milestone B estimate by more than \$2.5 billion. This would represent a total approaching \$12 billion (then-year dollars) versus the current estimate of \$9.2 billion for the lead submarine.³⁷ Due to the magnitude of the Columbia class program’s expected cost, any cost growth, including for design and construction of the lead ship could impact the availability of funds for other Navy priorities.

³⁷ \$9.2 billion multiplied by 1.28 (average cost growth) equals \$11.8 billion.

The Congressional Budget Office (CBO) and CAPE also analyzed Columbia class program costs. CBO predicted higher costs than the Navy estimate. In its 2017 assessment of the Navy's long-term shipbuilding plans, CBO concluded that the Navy underestimated the cost of the total Columbia class procurement by \$8 billion (2017 dollars).³⁸

CAPE estimated a lower cost, but also identified areas where reliable cost data were unavailable. The independent cost estimate prepared by CAPE in support of the program's Milestone B reflects a 3 percent lower total program life-cycle cost (2017 dollars) than the Navy estimate. In setting the program baseline in January 2017, DOD pragmatically opted to use the Navy's higher estimate (\$7.3 billion) instead of CAPE's \$7 billion estimate for the average unit cost to procure a Columbia class submarine (calendar year 2017 dollars). According to CAPE officials, this difference in estimates is largely due to CAPE incorporating more recent Virginia class actual cost data into its estimate than the Navy. However, CAPE also identified that there is a lack of reliable cost data on some contractor-furnished materials and government furnished equipment (GFE) for the Columbia class program, which limited the quality of the estimate. GFE comprises critical areas of the Columbia class submarine, including the strategic weapon system managed by Strategic Systems Program and the IPS developed by Naval Reactors.

Conclusions

The Columbia class submarine will be a significant DOD acquisition for the next several decades due to cost and mission importance in guaranteeing the nation's strategic deterrence. Failure to meet the aggressive patrol dates required of the program could challenge the Navy in effectively meeting strategic patrol requirements, and not delivering the required level of performance could compromise the Navy's plan to operate this class through 2080.

Given the risks facing the program and the significance of potential delays or cost growth, we believe this program warrants increased attention to and scrutiny over what we consider to be its critical technologies (inclusive of the program's stated technology development efforts), several of which remain immature. Specifically, technologies such as IPS

³⁸CBO, *An Analysis of the Navy's Fiscal Year 2017 Shipbuilding Plan*, (Washington, D.C.: February 2017).

and the propulsor and coordinated stern demand more specific congressional visibility to ensure they stay on track. These areas also warrant specific assurances from the Navy that they will be delivered on time and will perform as required. This assurance could augment the Milestone B certifications which were predicated on a TRA that was not representative of the technical risk facing the program. Further, such information would help bolster confidence for Congress that the program technologies will be matured in time to support construction, which is especially important as the Navy pursues plans to start construction of the lead ship early. Without putting in place a requirement for the Navy to provide these assurances on a periodic basis, Congress will not have the information until after the Navy has asked for another \$8.7 billion in funding for lead ship construction. It is also important for Congress to be informed of the impact on performance requirements if technologies are delayed or fail to mature as planned.

The Columbia class program is also facing risks from its aggressive and concurrent schedule as a result of the continued and pressing need for it to meet the Navy's nuclear deterrent requirements as the legacy submarine fleet that cannot be life extended any longer. Typically addressing risks of such concurrency is accomplished by, among other things, delaying milestones until more knowledge is obtained. Doing so helps reduce concurrency and bring more stability to the design before construction activities begin. Recognizing the mission imperatives that are driving Columbia class's aggressive and concurrent schedule it is unlikely that the Navy will have the ability to slow the pace of the program in order to reduce cost and schedule risk. Therefore, additional reporting to decisionmakers on the status of key technologies could help ensure they fully understand the risks of such an approach and account for such risks when making programmatic decisions.

Matter for Congressional Consideration

In our draft report we had suggested a matter for congressional consideration related to additional Navy reporting on the Columbia class technologies, but we have since removed it because the recently passed National Defense Authorization Act (NDAA) for 2018 includes Navy reporting requirements for the Columbia class program that would achieve the intent of our matter.

Agency Comments and our Evaluation

We provided a draft of this product to DOD for comment. The Navy provided technical comments earlier in the review process which we incorporated where appropriate. In its written comments, reproduced in appendix III, DOD's position was that there is not a need for additional congressional reporting on the Columbia class program because there are new reporting requirements in the conference report accompanying the NDAA for fiscal year 2018. We agree that the reporting requirements in the section 231 of the NDAA for Fiscal Year 2018 meet the intent of our matter for congressional consideration. These new reporting requirements for the Navy became law on December 12, 2017, after we sent the report to DOD and appropriate congressional committees. We agree that the reporting requirements meet the intent of our matter for congressional consideration. Accordingly, we have removed our matter from this report.

In addition, DOD also disagreed with our characterization of technical risks facing the Columbia class program and its TRA. Specifically, DOD stated that the program is meeting statutory and DOD maturity standards and met or exceeded DOD technology maturity requirements. DOD also stated that the program's TRA was conducted in accordance with a 2011 DOD policy memo that directed TRA's should focus only on "technology maturity, as opposed to engineering and integration risk." However, neither this policy memo nor the Columbia class TRA define what constitutes engineering and integration risk and it is unclear what criteria the Navy used in making these determinations. Our report acknowledges that DOD followed statutory and DOD requirements for the two technologies that the Navy identified as critical technologies in the program's TRA. However, our report also identifies several other technologies that we believe should have also been subject to these requirements had the Navy conducted a TRA in accordance with our identified best practices. By applying our identified best practices, we believe these efforts would have been considered critical technologies and would have been subject to an evaluation of technology maturity levels, additional reporting requirements and, potentially, identification of additional risk mitigation efforts.

DOD also disagreed with our criteria for identifying a critical technology and assessing maturity. DOD asserted that applying our criteria would result in nearly every system on a submarine becoming a critical technology. We disagree. Our criteria are consistent with DOD's own

criteria for identifying critical technologies, and only focus on those that are most significant to a program. Given the program's cost and schedule risks and operational imperatives, we believe that appropriately identifying the critical technologies is an important step in acknowledging and mitigating program risk. DOD also stated that achieving a TRL 7 by milestone B would be unrealistic because of the difficulties in testing some systems in an operational environment prior to launching the submarine. We agree that in some cases testing at sea is not practical and testing in a relevant environment may be sufficient to demonstrate maturity. However, achieving a TRL 7 is not only based on the test environment; it is also based on demonstrating a prototype near or at the planned operational system configuration, which requires a design resembling the final configuration. The Columbia class program has yet to complete this type of prototype for the key systems we identified. As we stated in the report some systems, like the propulsor, do not yet have a final design. While we do not expect the Navy to test every critical technology on a submarine at sea to demonstrate maturity, we would expect testing of a prototype near or at the planned operational system configuration prototype in a relevant environment. For example, prototype testing of the electric drive at a land-based test facility would demonstrate maturity—but is not planned for several years—well after the submarine's design and potentially construction is underway. While such concurrency introduces cost, schedule and technical risk, we have previously reported that programs may choose to move forward with these risks, but should acknowledge and appropriately resource the program to address the risks should they materialize. As we stated in the report, this is not the case for the Columbia class program: some risks have not been properly identified and the cost estimate does not fully account for the margin of technical and schedule risks facing the program.

DOD also provided a table of Columbia class practices, reprinted with our comments in appendix III.

We are sending copies of this report to the appropriate congressional committees; the Secretary of Defense, the Secretary of the Navy, and other interested parties. This report will also be available at no charge on GAO's website at <http://www.gao.gov>.

If you or your staff members have any questions regarding this report, please contact me at (202) 512-4841 or oakleys@gao.gov. Contact points for our Offices of Congressional Relations and Public Affairs may be found on the last page of this report. GAO staff who made key contributions to the report are listed in appendix IV.

A handwritten signature in black ink that reads "Shelby S. Oakley". The signature is written in a cursive, flowing style.

Shelby S. Oakley
Director, Acquisition and Sourcing Management

List of Committees

The Honorable John McCain
Chairman
The Honorable Jack Reed
Ranking Member
Committee on Armed Services
United States Senate
The Honorable Thad Cochran
Chairman
The Honorable Richard Durbin
Ranking Member
Subcommittee on Defense
Committee on Appropriations
United States Senate
The Honorable Mac Thornberry
Chairman
The Honorable Adam Smith
Ranking Member
Committee on Armed Services
House of Representatives
The Honorable Kay Granger
Chairwoman
The Honorable Peter J. Visclosky
Ranking Member
Subcommittee on Defense
Committee on Appropriations
House of Representatives

Appendix I: Objectives, Scope, and Methodology

This report examines (1) the status of key Columbia class technologies and congressional reporting requirements on this status, (2) risks, if any, with the Navy's planned approach for design and construction, and (3) whether expected funding levels for the Columbia class will be adequate moving forward.

To assess the status of key Columbia class technologies, we reviewed the Navy's technology development plan and the planned technical approach and the status of key prototyping efforts to all of the systems that comprise the program, focusing on the technology readiness level of the major components that are key to enabling program success and that are key cost and schedule drivers. We also compared technology development efforts with program requirements and with GAO's identified best practices for shipbuilding programs. We also evaluated the program's Technology Readiness Assessment, which included applying the GAO-developed criteria documented in GAO's Technology Assessment Guide. GAO's guide draws heavily from the Department of Defense (DOD), Energy (DOE), and National Aeronautics and Space Administration (NASA) best practices, and establishes a methodology based on those best practices that can be used across the federal government for evaluating technology maturity, particularly as it relates to determining a program or project's readiness to move past key decision points that typically coincide with major commitments of resources. We also interviewed relevant officials from the Navy's Columbia class submarine program office; the Office of the Chief of Naval Operations-Undersea Warfare; Naval Sea Systems Command Naval Nuclear Propulsion Program; Navy Strategic Systems Program; Naval Undersea Warfare Center Newport; Naval Surface Warfare Center Carderock Division; Office of the Secretary of Defense (OSD) Director Operational Test and Evaluation; OSD Acquisition, Technology, and Logistics (AT&L); OSD Cost Analysis and Program Evaluation (CAPE); and the prime contractor shipyard General Dynamics Electric Boat and their sub-contractor Huntington Ingalls Industries Newport News Shipbuilding. To determine the congressional reporting requirements on this status we reviewed relevant DOD acquisition instructions and statute.

To assess the risks, if any, with the Navy's planned approach for design and construction, we compared the status of design maturity with Navy and shipyard plans to identify any delays, and compared planned design maturity and schedule projections with those of prior U.S. submarine efforts (the Virginia, Seawolf, and Ohio classes) to assess realism of Columbia class estimates. We also interviewed and analyzed available documentation from Naval Reactors (NAVSEA 08) related to nuclear reactor and Integrated Power System status. We also interviewed relevant officials from the Navy's Columbia class submarine program office; Naval Sea Systems Command Naval Nuclear Propulsion Program; Naval Surface Warfare Center Carderock Division, and the prime contractor shipyard General Dynamics Electric Boat and their sub-contractor Huntington Ingalls Industries Newport News Shipbuilding. We also assessed the Navy's acquisition strategy and the Integrated Enterprise Plan that tracks shipyard workload across the Columbia and Virginia class submarines and the Ford class aircraft carrier to identify any factors related to potential schedule challenges.

To assess whether expected funding levels for the Columbia class will be adequate moving forward, we compared program cost estimates prepared at Milestone B to historical data on lead ships and submarine estimates and actuals to assess the realism of these requirements. We also analyzed program documentation to identify risk factors, if any, related to cost projections, including the program's Independent Cost Estimate created by the OSD Cost Analysis and Program Evaluation, and the Navy's Service Cost Position and Program Life Cycle Cost Estimate. This evaluation leverages, among other things, prior GAO work on cost estimating and the Navy's acquisition of lead ships.

We also interviewed relevant officials from the Navy's Columbia class submarine program office; the Office of the Chief of Naval Operations-Undersea Warfare; Naval Sea Systems Command Naval Nuclear Propulsion Program; Naval Undersea Warfare Center; Naval Surface Warfare Center Carderock Division; OSD Director Operational Test and Evaluation; OSD AT&L; CAPE; and the prime contractor shipyard General Dynamics Electric Boat and their sub-contractor Huntington Ingalls Industries Newport News Shipbuilding.

We conducted this performance audit from May 2016 to December 2017 in accordance with generally accepted government auditing standards. Those standards require that we plan and perform the audit to obtain sufficient, appropriate evidence to provide a reasonable basis for our findings and conclusions based on our audit objectives. We believe that

the evidence obtained provides a reasonable basis for our findings and conclusions based on our audit objectives.

Appendix II: Department of Defense Technology Readiness Levels

Table 4: Department of Defense Technology Readiness Levels (TRL)

TRL	Definition	Description
1.	Basic principles observed and reported	Lowest level of technology readiness. Scientific research begins to be translated into applied research and development (R&D). Examples might include paper studies of a technology's basic properties.
2.	Technology concept and/or applications formulated	Invention begins. Once basic principles are observed, practical applications can be invented. Applications are speculative and there may be no proof or detailed analysis to support the assumptions. Examples are limited to analytic studies.
3.	Analytical and experimental function and/or characteristic proof of concept	Active R&D is initiated. This includes analytical studies and laboratory studies to physically validate the analytical predictions of separate elements of the technology. Examples include components that are not yet integrated or representative.
4.	Component and/or breadboard validation in a laboratory environment	Basic technological components are integrated to establish that they will work together. This is relatively "low fidelity" compared with the eventual system. Examples include integration of "ad hoc" hardware in the laboratory.
5.	Component and/or breadboard validation in a relevant environment	Fidelity of breadboard technology increases significantly. The basic technological components are integrated with reasonably realistic supporting elements so they can be tested in a simulated environment. Examples include "high-fidelity" laboratory integration of components.
6.	System/subsystem model or prototype demonstration in a relevant environment	Representative model or prototype system, which is well beyond that of TRL 5, is tested in a relevant environment. Represents a major step up in a technology's demonstrated readiness. Examples include testing a prototype in a high-fidelity laboratory environment or in a simulated operational environment.
7.	System prototype demonstrated in an operational environment	Prototype near or at planned operational system. Represents a major step up from TRL 6 by requiring the demonstration of an actual system prototype in an operational environment (e.g., in an aircraft, in a vehicle, or in space).
8.	Actual system completed and qualified through test and demonstration.	Technology has been proven to work in its final form and under expected conditions. In almost all cases, this TRL represents the end of the true system development. Examples include developmental test and evaluation of the system in its intended weapon system to determine if it meets design specifications.
9.	Actual system proven through successful mission operations.	Actual application of the technology in its final form and under mission conditions, such as those encountered in operational test and evaluations. Examples include using the system under operational conditions.

Source: GAO, Defense Acquisitions: Assessments of Selected Weapon Programs, [GAO-17-333SP](#) (Washington, D.C., Mar 30, 2017) | GAO-18-158

Appendix III: Comments from the Department of Defense

Note: GAO comments
supplementing those in
the report text appear at
the end of this appendix.



ACQUISITION

OFFICE OF THE ASSISTANT SECRETARY OF DEFENSE

3600 DEFENSE PENTAGON
WASHINGTON, DC 20301-3600

DEC - 1 2017

Ms. Michelle Mackin
Director, Acquisition and Sourcing Management
U.S. Government Accountability Office
441 G Street, N.W.
Washington DC 20548

Dear Ms. Mackin:

This is the Department of Defense's (DoD) response to the Government Accountability Office (GAO) Draft Report, GAO-18-158, "COLUMBIA CLASS SUBMARINE: Immature Technologies Present Risks to Achieving Cost, Schedule, and Performance Goals," dated October 31, 2017 (GAO Code 100841).

The draft report recommends Congress consider requiring the Navy to submit bi-annual reporting on the status of key COLUMBIA Class Submarine technologies. In light of recent reporting requirements included in the Fiscal Year 2018 National Defense Authorization Act Conference Report and the COLUMBIA program's history of close interaction with the Navy, DoD, and Congress, additional reporting requirements are unnecessary. The Navy currently provides regular updates to Congress, including the status of technologies discussed in the draft report, construction readiness progress, and cost reduction efforts, and will remain responsive to future congressional requests.

The COLUMBIA program complied with all Navy, DoD, and statutory requirements for conducting its 2015 Technical Readiness Assessment (TRA). There are several instances in the draft report that suggest otherwise and are further clarified below:

- The GAO Draft Report's title may miscommunicate the COLUMBIA program's status. All COLUMBIA technologies are meeting statutory and DoD maturity standards and the program complied with all statute and policy related to design and development. COLUMBIA properly achieved Milestone (MS) B and met or exceeded DoD technology maturity requirements.
- The program accurately represented all technology risks. The TRA was conducted in accordance with requirements under 10 U.S.C. and DoD guidance from May 2011 on improving TRA effectiveness. This guidance stated a TRA should "focus only on technology maturity, as opposed to engineering and integration risk." Since the Common Missile Compartment, Integrated Power System (IPS), nuclear reactor, and propulsor are engineering and integration efforts, rather than technology maturity efforts, labeling them as critical technologies was not required. While these systems are not considered critical technology, the COLUMBIA program continues to actively manage related engineering and integration risks.
- An independent panel of Navy technical experts conducted a review of COLUMBIA program requirements, design status, technology development efforts, and engineering and integration efforts. Based on the established criteria, the TRA Panel identified two critical

technologies: Advanced Carbon Dioxide Removal Unit (ACRU) and Stern Area System (SAS). The Navy Chief Engineer, Deputy Assistant Secretary of the Navy for Research Development Test and Evaluation, and Assistant Secretary of Defense for Research and Engineering independently reviewed and concurred with the TRA Panel's findings. Adoption of GAO's broader criteria for determining critical technologies, would result in almost every system on a submarine being identified as a critical technology, including the hull.

- There is a historical dialogue between the DoD and GAO regarding the Technology Readiness Level (TRL) required to achieve MS B. DoD programs are required to meet TRL 6 (system/subsystem model or prototype demonstration in a **relevant environment**) while the GAO's "best practices" recommends TRL 7 (system prototype near or at the planned operational system demonstrated in an **operational environment**). The GAO draft report acknowledged this difference of opinion and that the DoD verified the COLUMBIA program met the TRL 6 requirement for ACRU and received a waiver for SAS in accordance with federal statute prior to achieving MS B.
- Attaining TRL 7 before MS B, as recommended by GAO, is not practical for shipbuilding programs. This approach would require all technologies on a shipbuilding program to be prototyped at full-scale and demonstrated in at-sea environments – essentially, building a full-size prototype submarine – before authorizing lead ship construction. Proving out COLUMBIA technologies to the level prescribed by GAO would require Congress to provide a significant amount of additional program funding and delay lead ship construction, thereby threatening U.S. Strategic Command at-sea deterrence requirements. While designing, building, and operating a full-scale submarine with all new technologies would provide additional information on technical risks, the information expected to be gained would not justify the large-scale commitment of required funding and time. Instead, the Navy developed, and the DoD approved, a detailed risk mitigation plan for all major technical efforts planned for COLUMBIA.

The COLUMBIA program has adopted key tenets to promote success in meeting cost, schedule, and performance requirements. These tenets are detailed in Table 1 (enclosed) and seek to maintain stable operational and technical requirements, achieve high design maturity at construction start, ensure manufacturing and construction readiness, and take aggressive action to reduce costs.

The Department appreciates the opportunity to comment on the report. For further questions, please contact Dr. James Moreland, Deputy Director, Naval Warfare, 703-614-3170.

Sincerely,



James A. MacStravic
Acting Assistant Secretary of Defense
for Acquisition

Enclosure:
As stated

Appendix III: Comments from the Department of Defense

Table 1 – COLUMBIA Class Key Tenets to Achieving Cost, Schedule, and Performance

Stable Operational and Technical Requirements	<p>To ensure that the submarines remain viable into the 2080s, the Navy’s Fleet representatives, U.S. Strategic Command and other Navy and DoD stakeholders participated in the development of COLUMBIA Class’ Capability Development Document (CDD) that established the program requirements. As part of translating the operational requirements in the CDD to technical requirements for the ship design, the Navy completed detailed ship specifications. The Navy has established a strict process to evaluate any proposed changes to the specifications to determine why the change is required, why the existing specification is not sufficient and the associated cost/schedule implications. Any ship specification change must be approved by Navy leadership.</p>
High Design Maturity at Construction Start	<p>Previous Navy shipbuilding programs have demonstrated that a more mature design at construction start is closely tied to lower costs and less time to deliver the ship. To reduce cost and schedule risk, the COLUMBIA Program tracks design maturity through the completion of design products and has established a target to complete 83% of design products by the start of lead ship construction in FY2021. For comparison, VIRGINIA Class SSN design maturity at construction start was 43 percent, and FORD Class CVN design maturity was 27 percent.</p> <p>One key enabler of achieving a high degree of design maturity is leveraging the successes of other recent submarine design programs. Design elements from the VIRGINIA and OHIO Class submarine programs are being used as starting points for the COLUMBIA Class design. Specific examples include: (1) Significant portions of COLUMBIA systems are design reuse from VIRGINIA including the propulsor, which uses the same technology as VIRGINIA system (TRL 9); (2) The Common Missile Compartment (CMC) leverages the proven reliability (TRL 9) of the Trident II (D5) Strategic Weapon System (SWS) and the COLUMBIA SSBN will enter service with the re-hosted Trident II (D5) SWS. To manage and mitigate technical risk, the Navy’s Strategic Systems Programs (SSP) is leading the development of test sites to: (1) conduct integration testing, verification and validation of selected CMC systems and (2) prove that the launcher industrial base can replicate the performance of the OHIO Class Trident II (D5) launcher system.</p> <p>Finally, for all systems, the Navy closely monitors the progress of the contractor design team in the areas of technical quality and adherence to cost and schedule.</p>
Manufacturing and Construction Readiness	<p>Previous submarine construction programs have proven that extensive prototyping technologies and manufacturing approaches are critical to managing construction cost and schedule. To meet the aggressive 84-month construction span needed to allow time for testing between ship delivery and first deployment, the COLUMBIA Class has taken several actions to ensure manufacturing readiness including the fabrication of prototypes to mitigate technical, schedule, cost and manufacturing risks. The Navy has also worked with the shipbuilders to identify facility requirements necessary to ensure the success of both concurrent VIRGINIA and COLUMBIA Class submarine construction.</p>
Aggressive Action to Reduce Cost	<p>The COLUMBIA Program has taken a wide variety of technical and programmatic actions to reduce cost for government and contractor non-recurring engineering, construction, and operation and support. These actions include: the reuse of designs from previous submarine classes; institutionalizing the Design for Affordability program to identify, develop, evaluate, promote, and document specific cost reduction initiatives; and execution of an enterprise-wide build strategy that takes advantage of synergies between COLUMBIA and VIRGINIA Class build plans to the maximum extent practical and capitalize on material procurements spanning COLUMBIA and VIRGINIA Class Submarines and FORD Class carriers.</p> <p>In setting the MS B program baseline in January 2017, DoD decided to fund the COLUMBIA Program to the Navy’s cost position, even though the Navy’s cost position was slightly higher than OSD CAPE’s Independent Cost Estimate (ICE). OSD CAPE noted in their ICE memo that additional significant cost savings are possible in the program (i.e., material savings with VIRGINIA). The Congressional Budget Office (CBO) prepared an Analysis of the Navy’s Fiscal Year 2017 Shipbuilding Plan of February 2017 which provided a higher estimate compared to the COLUMBIA MS B estimate, but also acknowledged that “the costs for the COLUMBIA Class could be lower than the Navy and CBO project, depending on the acquisition strategy.” Since MS B, cost reduction initiatives included in PB18 have reduced the program’s Average Procurement Unit Cost (APUC) by approximately \$100M (CY17\$) to \$7.2B (CY17\$). The program continues to pursue cost reductions opportunities while ensuring that future cost growth is avoided.</p>

GAO Comments

DOD also provided the above table of Columbia class practices. These practices align with GAO's identified best practices in shipbuilding—stable requirements, design maturity at construction start, and manufacturing readiness. However, we have several observations on the DOD's statements:

Stable Operational and Technical Requirements:

- We have previously identified maintaining stable requirements as a best practice; in this report we note that the Navy has provided a stable basis for the Columbia class program by adhering to this practice.

High Design Maturity at Construction Start:

- While we give credit to the program for striving for a high level of design maturity at construction start for the Columbia class program, we identify in this report that we have concerns about the Navy's ability to stabilize design drawings while technology development continues.
- As we point out in this report, we are concerned with the maturity of the Columbia class design due to the unknowns with key technologies. In this table the Department identifies that the program is leveraging proven Virginia class technology for the propulsor, which it identifies as a TRL 9. Although this technology is indeed mature in the context of Virginia class submarines (i.e., not new or novel), it is nevertheless novel in the context of Columbia class submarines and should thus be considered a CTE to be evaluated and risk managed. As such, we dispute the Navy's assertion that the Virginia class propulsor is TRL 9 in the context of the Columbia class program, since the Navy has yet to complete a design for the propulsor nor has it tested a production representative prototype, which would achieve a TRL 6 or 7 (depending on the test environment).

Manufacturing and Construction Readiness:

- We have not conducted adequate work in this area to comment on DOD's statements of manufacturing and construction readiness; we plan to address this in future work.

Aggressive Action to Reduce Costs:

-
- While the Navy has made significant progress in reducing potential costs for the Columbia class program, we believe that the risks identified in this report, coupled with the optimistic cost estimate and aggressive schedule, could result in cost growth that reduces the actual savings identified by the program.

Appendix IV: GAO Contact and Staff Acknowledgments

GAO Contact

Shelby S. Oakley, (202) 512-4841 or oakleys@gao.gov

Staff Acknowledgments

In addition the contact name above, the following staff members made key contributions to this report: Diana Moldafsky, Assistant Director; C. James Madar; Jacob Leon Beier; Brian Bothwell; Herb Bowsher; Kurt Gurka; Stephanie Gustafson; Tim Persons; and Robin Wilson.

Appendix V: Accessible Data

Data Tables

Accessible Data for Figure 1: The United States Nuclear Triad Airborne strategic deterrent

- 60 heavy bombers (deployed strategic delivery vehicle)

Ground-based strategic deterrent

- 400 intercontinental ballistic missiles (deployed strategic delivery vehicle)

Sea-based strategic deterrent

- 240 submarine-launched ballistic missiles (deployed strategic delivery vehicle), which are carried on ballistic missile submarines

Accessible Data for Figure 7: Overview of Columbia Class Life-Cycle Cost Estimate (Then-Year Dollars, Millions)

Operations and support	138910.50
Total acquisition	128238.10

Total acquisition categories	Total acquisition
Military construction	173.40
Research, development, test and evaluation	13,020.30
Procurement	115044.40

Accessible Data for Figure 8: Acquisition Plans for the Columbia Class Submarine (in calendar year)

Date	Event
February 2008	Reactor plant and propulsion development contract award
January 2011	Milestone A, start of Columbia class technology development
June 2011	Propulsion plant design contract awarded

Date	Event
December 2012	Research and Development contract award
October 2015	Strategic weapons system contracts awarded
January 2017	Milestone B, start of Columbia class system development
September 2017	Design completion contract award
March 2018	Block 1 (Columbia 1 and 2) advanced procurement, long-lead time materials (LLTM), and continuous production contract awarded
February 2020	Budget request for lead ship authorization and funding
May 2020	Production Readiness Review
October 2020	Block I contract award; Columbia 1 construction start
October 2023	Block II (Columbia 3, 4, and 5) LLTM, manufacturing, and construction contract award
March 2024	Columbia 2 starts construction
March 2026	Columbia 3 starts construction
October 2027	Columbia 1 contract delivery; developmental test and evaluation trials
September 2028	Columbia 1 missile qualification testing begins
April 2029	Columbia 1 post-shakedown availability
April 2030	Columbia 1 final missile qualification testing
October 2030	Columbia 1 available for patrol

Accessible Data for Figure 13: Estimated and Actual Schedules for U.S. Navy Lead Submarines (months)

Lead submarines	Estimated build span (in months)	Actual build span (in months)
Ohio (SSBN 726)	57	88
Seawolf (SSN 21)	67	92
Virginia (SSN 774)	84	88
Virginia (SSN 775)	84	96
Columbia (SSBN 826)	84	N/A

Accessible Data for Figure 15: Cost Growth in Program Budgets for the Three Lead Navy Submarines Authorized to Start Construction since 1989

Lead submarines	Cost growth (percentage)	Average cost growth (percentage)
Seawolf (SSN 21)	45	28
Virginia (SSN 774)	15	28
Virginia (SSN 775)	25	28

Agency Comment Letter

Accessible Text for Appendix III: Comments from the Department of Defense

Page 1

OFFICE OF THE ASSISTANT SECRETARY OF DEFENSE

3600 DEFENSE PENTAGON

WASHINGTON, DC 20301-3600

DEC - 1 2017

Ms. Michelle Mackin

Director, Acquisition and Sourcing Management

U.S. Government Accountability Office

441 G Street, N.W.

Washington DC 20548

Dear Ms. Mackin:

This is the Department of Defense's (DoD) response to the Government Accountability Office (GAO) Draft Report, GAO-18-158, "COLUMBIA CLASS SUBMARINE: Immature Technologies Present Risks to Achieving Cost, Schedule, and Performance Goals," dated October 31, 2017 (GAO Code 100841).

The draft report recommends Congress consider requiring the Navy to submit bi-annual reporting on the status of key COLUMBIA Class Submarine technologies. In light of recent reporting requirements included in the Fiscal Year 2018 National Defense Authorization Act Conference Report and the COLUMBIA program's history of close interaction with the Navy, DoD, and Congress, additional reporting requirements are unnecessary. The Navy currently provides regular updates to Congress, including the status of technologies discussed in

the draft report, construction readiness progress, and cost reduction efforts, and will remain responsive to future congressional requests.

The COLUMBIA program complied with all Navy, DoD, and statutory requirements for conducting its 2015 Technical Readiness Assessment (TRA). There are several instances in the draft report that suggest otherwise and are further clarified below:

The GAO Draft Report's title may miscommunicate the COLUMBIA program's status. All COLUMBIA technologies are meeting statutory and DoD maturity standards and the program complied with all statute and policy related to design and development. COLUMBIA properly achieved Milestone (MS) B and met or exceeded DoD technology maturity requirements.

The program accurately represented all technology risks. The TRA was conducted in accordance with requirements under 10 U.S.C. and DoD guidance from May 2011 on improving TRA effectiveness. This guidance stated a TRA should “focus only on technology maturity, as opposed to engineering and integration risk.” Since the Common Missile Compartment, Integrated Power System (IPS), nuclear reactor, and propulsor are engineering and integration efforts, rather than technology maturity efforts, labeling them as critical technologies was not required. While these systems are not considered critical technology, the COLUMBIA program continues to actively manage related engineering and integration risks.

An independent panel of Navy technical experts conducted a review of COLUMBIA program requirements, design status, technology development efforts, and engineering and integration efforts. Based on the established criteria, the TRA Panel identified two critical

Page 2

technologies: Advanced Carbon Dioxide Removal Unit (ACRU) and Stem Area System (SAS). The Navy Chief Engineer, Deputy Assistant Secretary of the Navy for Research Development Test and Evaluation, and Assistant Secretary of Defense for Research and Engineering independently reviewed and concurred with the TRA Panel's findings. Adoption of GAO's broader criteria for determining critical technologies, would result in almost every system on a submarine being identified as a critical technology, including the hull.

There is a historical dialogue between the DoD and GAO regarding the Technology Readiness Level (TRL) required to achieve MS B. DoD programs are required to meet TRL 6 (system/subsystem model or prototype demonstration in a relevant environment) while the GAO's "best practices" recommends TRL 7 (system prototype near or at the planned operational system demonstrated in an operational environment). The GAO draft report acknowledged this difference of opinion and that the DoD verified the COLUMBIA program met the TRL 6 requirement for ACUR and received a waiver for SAS in accordance with federal statute prior to achieving MS B.

Attaining TRL 7 before MS B, as recommended by GAO, is not practical for shipbuilding programs. This approach would require all technologies on a shipbuilding program to be prototyped at full-scale and demonstrated in at-sea environments — essentially, building a full-size prototype submarine — before authorizing lead ship construction. Proving out COLUMBIA technologies to the level prescribed by GAO would require Congress to provide a significant amount of additional program funding and delay lead ship construction, thereby threatening U.S. Strategic Command at-sea deterrence requirements. While designing, building, and operating a full-scale submarine with all new technologies would provide additional information on technical risks, the information expected to be gained would not justify the large-scale commitment of required funding and time. Instead, the Navy developed, and the DoD approved, a detailed risk mitigation plan for all major technical efforts planned for COLUMBIA.

The COLUMBIA program has adopted key tenets to promote success in meeting cost, schedule, and performance requirements. These tenets are detailed in Table 1 (enclosed) and seek to maintain stable operational and technical requirements, achieve high design maturity at construction start, ensure manufacturing and construction readiness, and take aggressive action to reduce costs.

The Department appreciates the opportunity to comment on the report. For further questions, please contact Dr. James Moreland, Deputy Director, Naval Warfare, 703-614-3170.

Sincerely,

James A. MacStravic

Acting Assistant Secretary of Defense for Acquisition

Enclosure: As stated

Page 3

Table 1 — COLUMBIA Class Key Tenets to Achieving Cost, Schedule, and Performance

Stable Operational and Technical Requirements:

- To ensure that the submarines remain viable into the 2080s, the Navy's Fleet representatives, U.S. Strategic Command and other Navy and DoD stakeholders participated in the development of COLUMBIA Class' Capability Development Document (CDD) that established the program requirements. As part of translating the operational requirements in the CDD to technical requirements for the ship design, the Navy completed detailed ship specifications. The Navy has established a strict process to evaluate any proposed changes to the specifications to determine why the change is required, why the existing specification is not sufficient and the associated cost/schedule implications. Any ship specification change must be approved by Navy leadership.

High Design Maturity at Construction Start:

- Previous Navy shipbuilding programs have demonstrated that a more mature design at construction start is closely tied to lower costs and less time to deliver the ship. To reduce cost and schedule risk, the COLUMBIA Program tracks design maturity through the completion of design products and has established a target to complete 83% of design products by the start of lead ship construction in FY2021. For comparison, VIRGINIA Class SSN design maturity at construction start was 43 percent, and FORD Class CVN design maturity was 27 percent.
- One key enabler of achieving a high degree of design maturity is leveraging the successes of other recent submarine design programs. Design elements from the VIRGINIA and OHIO Class submarine programs are being used as starting points for the COLUMBIA Class design. Specific examples include: (1) Significant portions of COLUMBIA systems are design reuse from VIRGINIA including the propulsor, which uses the same

technology as VIRGINIA system (TRL 9); (2) The Common Missile Compartment (CMC) leverages the proven reliability (TRL 9) of the Trident II (D5) Strategic Weapon System (SWS) and the COLUMBIA SSBN will enter service with the re-hosted Trident II (D5) SWS. To manage and mitigate technical risk, the Navy's Strategic Systems Programs (SSP) is leading the development of test sites to: (1) conduct integration testing, verification and validation of selected CMC systems and (2) prove that the launcher industrial base can replicate the performance of the OHIO Class Trident II (D5) launcher system.

- Finally, for all systems, the Navy closely monitors the progress of the contractor design team in the areas of technical quality and adherence to cost and schedule.

Manufacturing and Construction Readiness:

- Previous submarine construction programs have proven that extensive prototyping technologies and manufacturing approaches are critical to managing construction cost and schedule. To meet the aggressive 84-month construction span needed to allow time for testing between ship delivery and first deployment, the COLUMBIA Class has taken several actions to ensure manufacturing readiness including the fabrication of prototypes to mitigate technical, schedule, cost and manufacturing risks. The Navy has also worked with the shipbuilders to identify facility requirements necessary to ensure the success of both concurrent VIRGINIA and COLUMBIA Class submarine construction.

Aggressive Action to Reduce Cost:

- The COLUMBIA Program has taken a wide variety of technical and programmatic actions to reduce cost for government and contractor non-recurring engineering, construction, and operation and support. These actions include: the reuse of designs from previous submarine classes; institutionalizing the Design for Affordability program to identify, develop, evaluate, promote, and document specific cost reduction initiatives; and execution of an enterprise-wide build strategy that takes advantage of synergies between COLUMBIA and VIRGINIA Class build plans to the maximum extent practical and capitalize on material procurements spanning COLUMBIA and VIRGINIA Class Submarines and FORD Class carriers.

- In setting the MS B program baseline in January 2017, DoD decided to fund the COLUMBIA Program to the Navy's cost position, even though the Navy's cost position was slightly higher than OSD CAPE's Independent Cost Estimate (ICE). OSD CAPE noted in their ICE memo that additional significant cost savings are possible in the program (i.e., material savings with VIRGINIA). The Congressional Budget Office (CBO) prepared an Analysis of the Navy's Fiscal Year 2017 Shipbuilding Plan of February 2017 which provided a higher estimate compared to the COLUMBIA MS B estimate, but also acknowledged that "the costs for the COLUMBIA Class could be lower than the Navy and CBO project, depending on the acquisition strategy." Since MS B, cost reduction initiatives included in PB18 have reduced the program's Average Procurement Unit Cost (APUC) by approximately \$100M (CY I 7\$) to \$7.2B (CY I 7\$). The program continues to pursue cost reductions opportunities while ensuring that future cost growth is avoided.

GAO's Mission

The Government Accountability Office, the audit, evaluation, and investigative arm of Congress, exists to support Congress in meeting its constitutional responsibilities and to help improve the performance and accountability of the federal government for the American people. GAO examines the use of public funds; evaluates federal programs and policies; and provides analyses, recommendations, and other assistance to help Congress make informed oversight, policy, and funding decisions. GAO's commitment to good government is reflected in its core values of accountability, integrity, and reliability.

Obtaining Copies of GAO Reports and Testimony

The fastest and easiest way to obtain copies of GAO documents at no cost is through GAO's website (<http://www.gao.gov>). Each weekday afternoon, GAO posts on its website newly released reports, testimony, and correspondence. To have GAO e-mail you a list of newly posted products, go to <http://www.gao.gov> and select "E-mail Updates."

Order by Phone

The price of each GAO publication reflects GAO's actual cost of production and distribution and depends on the number of pages in the publication and whether the publication is printed in color or black and white. Pricing and ordering information is posted on GAO's website, <http://www.gao.gov/ordering.htm>.

Place orders by calling (202) 512-6000, toll free (866) 801-7077, or TDD (202) 512-2537.

Orders may be paid for using American Express, Discover Card, MasterCard, Visa, check, or money order. Call for additional information.

Connect with GAO

Connect with GAO on [Facebook](#), [Flickr](#), [LinkedIn](#), [Twitter](#), and [YouTube](#).
Subscribe to our [RSS Feeds](#) or [E-mail Updates](#). Listen to our [Podcasts](#).
Visit GAO on the web at www.gao.gov and read [The Watchblog](#).

To Report Fraud, Waste, and Abuse in Federal Programs

Contact:

Website: <http://www.gao.gov/fraudnet/fraudnet.htm>
E-mail: fraudnet@gao.gov
Automated answering system: (800) 424-5454 or (202) 512-7470

Congressional Relations

Orice Williams Brown, Managing Director, williamso@gao.gov, (202) 512-4400,
U.S. Government Accountability Office, 441 G Street NW, Room 7125,
Washington, DC 20548

Public Affairs

Chuck Young, Managing Director, youngc1@gao.gov, (202) 512-4800
U.S. Government Accountability Office, 441 G Street NW, Room 7149
Washington, DC 20548

Strategic Planning and External Liaison

James-Christian Blockwood, Managing Director, spel@gao.gov, (202) 512-4707
U.S. Government Accountability Office, 441 G Street NW, Room 7814,
Washington, DC 20548